

# AMT 885, 835, 825

---

**Warning:** This service manual is for use by Precor trained service providers only.

If you are not a Precor Trained Servicer, you must not attempt to service any Precor Product; Call your dealer for service.

This document contains information required to perform the majority of troubleshooting, and replacement procedures required to repair and maintain this product.

This document contains general product information, software diagnostic procedures (when available), preventative maintenance procedures, inspection and adjustment procedures, troubleshooting procedures, replacement procedures and electrical block and wiring diagrams.

**Acrobat Reader Users:**

To move directly to a procedure, click the appropriate procedure in the bookmark section to the left of this page. You may drag the separator bar between this page and the bookmark section to change the size of the page being viewed.

## Section One - Things you Should Know

### Right, Left, Front, and Back Conventions

In this manual, right, left, front, and back are from the perspective of a user standing on the AMT facing the display enclosure.

### General System Information

The generator performs three functions in the AMT. First, by controlling the amount of electrical current applied from the generator to a load circuit, the user's pedaling resistance is controlled. Second, the generator is used to charge the AMT's internal battery. Lastly, one of the generator's three phase output windings is monitored to determine when the unit is in use and when it is idle. This system also determines the step rate by determining the operating speed (output frequency) of the monitored generator winding. There is also a magnetic brake that applies resistance to horizontal motion and a sensor that measures horizontal motion (stride length).

### Warning and Caution Statements and General Safety Guidelines

Warning statements indicate a particularly dangerous activity. Warning statements you will find in this manual include:

- Because this is a self powered unit, it will either be necessary to either equip the unit with the optional external power supply or have an assistant pedal on the unit while voltage measurements are being taken. Because of the danger of working on the unit while it is in motion using the optional external power supply is strongly recommended.
- When the unit is used, stairarms are in motion; the generator will operate and produce potentially hazardous voltages even when the battery is disconnected.
- To remove power from the AMT, the optional external power supply (when equipped) must be disconnected from the wall outlet and the red (positive) wire must be disconnected from the battery. Always ensure that the AMT external power supply is unplugged from the wall outlet and the red (positive) wire is removed from the battery when you inspect or adjust the AMT, or when you isolate, remove, or replace an AMT component.
- Removing the covers exposes high voltage components and potentially dangerous machinery. Exercise extreme caution when you perform maintenance procedures with the cover(s) removed.
- During service operations you will be very close to moving machinery and voltage bearing components. When you perform maintenance procedures with the covers removed, remove jewelry (especially from ears and neck), tie up long hair, remove neck ties, and do not wear loose clothing.
- Exercise caution when touching any wire or electrical component during AMT operation.
- A pinching hazard exists when the unit is operated. It is possible to seriously pinch a finger. The AMT can be mechanically locked by inserting a screwdriver through the primary sheave and frame. See the illustration below. Locking the AMT will prevent accidental pinching.



- Caution statements are intended to prevent damage to the AMT as a result of the current activity. Caution statements included in this manual are listed below:
- When it is necessary to lift or move the AMT, ensure that the AMT has adequate support and that you use proper lifting techniques. When the rear platform is removed, the AMT may be lifted from the rear and moved like a wheelbarrow.

**Safety** guidelines you should know and follow include:

- Read the owner's manual and follow all operating instructions.
- Operate the AMT on a solid, level surface with the unit properly leveled. The AMT is properly leveled when all five feet are in contact with the floor. Visually check the AMT before beginning service or maintenance operations. If it is not completely assembled or is damaged in any way, exercise extreme caution while operating and checking the AMT.
- When operating the AMT, do not wear loose clothing. Do not wear shoes with heels or leather soles. Check the soles of your shoes and remove any embedded stones. Tie long hair back.
- Do not rock the unit. Do not stand or climb on the handlebars, display enclosure, or cover.
- Do not set anything on the handlebars, display enclosure, or cover. Never place liquids on any part of the AMT, while performing service.
- To prevent electrical shock, keep all electrical components away from water and other liquids.
- Do not use accessory attachments that are not recommended by the manufacturer-such attachments might cause injuries.

- AMT's equipped with Cardio Theater PVS units will have external power supply and coaxial cable routed through the bottom of the unit to the top of the display console. Cord management must be maintained.

## General Information

For the latest exploded view, part number and part pricing information, visit the Precor dealer website at [www.precor.com/connection](http://www.precor.com/connection).

## Tools Required

Multimeter

Anti-static kit

4 - 6 gear puller

Precor part number 20030-108 belt gauge

US and metric end wrench set

US and metric socket wrench set

Torque wrench, 200 in./lbs.

Torque wrench, 200 ft./lbs

Allen wrench set

Screwdriver set

## Section Two – Precor Console line

### Console Line

The AMT will be available with three different console options, the P80 and the P30. The following sections will provide procedures on replacing components and troubleshooting the two consoles. Choose the console section that applies to your AMT.

AMT 885 with P80 Console



AMT 835 with P30 Console



AMT 825 with P20 Console



Sections Three - P80 Console



## Procedure 3.1 – P80- Systems Settings

### Procedure

1. The Welcome screen will be the first screen you see when you approach the P80 console. Press the Pause key and continue holding it down while you **double press** (prior to 1.1 version software release) or **single press** (1.1 version or after software release) in sequential order an X configuration on the Volume and Channel key pad (① Channel Up, ② Volume Down, ③ Volume Up, ④ Channel Down). See Diagram 3.1.1. Release the Pause key when done pressing the arrows. **Note: The keypad X configuration sequence should be not faster than 1 second between each key stroke.** Any speed faster than 1 second may result in an unsuccessful access to the sign-in screen.
2. The sign-in screen will be displayed. Type in the technician access code and then touch OK. The Settings menu will be displayed. See Settings Table.
3. Use the System mode to configure settings in ways that benefit the users and the facility. Changes made to these settings save to the fitness equipment. To select a Setting touch on an item in the Settings menu.

Diagram 3.1.1

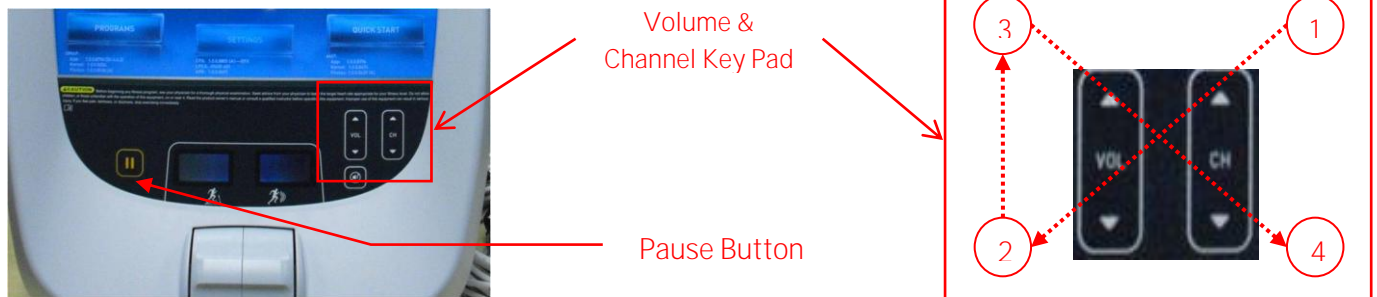

Settings			
Menu Item	Description	Navigation	Configure/View/Test
About	System information settings provide basic information including equipment models and serial numbers. Most of these settings are for informational purposes only and cannot be modified.	Touch About	See Procedure 3.2, About
Equipment Usage	The Equipment Usage settings provide information on individual usage as well as cumulative equipment usage. This information and these settings are accessible only to administrators and registered service technicians.	Touch Equipment Usage	See Procedure 3.3, Equipment Usage
System Settings	Use the System Settings to test your equipment and set parameters that benefit your users and your facility. The System Settings menu is visible only to administrators and registered service technicians.	Touch System Settings	See Procedure 3.4, System Settings
Software Downloads	Allows software to be automatically downloaded. It is recommended that this remain ON at all times. Contact Precor Customer Service before this setting is disabled.	Touch Software Downloads	Touch radio button next to On to Enable Automatic Downloads.  Default is ON  Touch radio button next to Off to Disable Automatic Downloads.
Reflashing	Used in advanced troubleshooting. Contact Precor Customer Service before changing these settings.	Touch Reflashing	Contact Precor Customer Service
Available Updates Or No Available Updates (Default)	The default is No Available Updates. When Software Downloads is enabled and a USB flash drive is installed that contains a valid software package, Available Updates will be displayed.	Touch Available Updates	Touch next to any of the available updates.  Touch View to see the details of the update. Touch ◀BACK to updates list.  Touch Install to load the update into the console.  See Procedure 3.5, Updating Software.

4. Touch ◀ BACK to the Welcome screen.



## Procedure 3.2- P80- About

1. Refer to Procedure 3.1 - Settings, to access the About menus.
2. About settings provide basic information including equipment models and serial numbers. Most of these settings are for informational purposes only and cannot be modified. See About Table. To select a About item, touch on an item in the About menu.

About			
Menu Item	Descriptions	Navigation	Configure/View/Test
Event Log	Provides a list of the most recent hardware and software events, and equipment status. If no events have occurred since the last time the event log was cleared, the event log screen will be empty.	Touch Event Log	Details of the Event will be listed. Touch REFRESH to update the list in the log. Touch SAVE to save the log to a Flash drive device. Touch ◀ BACK to About
Event Count	Number of events recorded by equipment over its lifetime.	None	None
Console Serial Number	Set by Precor and stored in the console's memory.	None	None
Lower Serial Number	Stored in the console's memory. Note: This information is not currently available to be displayed.	None	None
Location	Entered on console at the time of registration.	Touch Location	Displays location information. Touch ◀ BACK to About
Release Bundle Version	Shows current version of software. Automatically updates as part of each software upgrade.	Touch Release Bundle Version	Displays detailed information about the current software. Touch ◀ BACK to About
Etag Check Interval:	Determines how often the console will check for updates.	None	None
Heartbeat Interval	Determines how often the console communicates with the Server.	None	None
Minimum Heartbeat Interval	Minimum amount of time between heartbeats to the Preva server.	None	None
Maximum Heart beat Interval	Maximum amount of time between heartbeats to the Preva server.	None	None
Mfe MAC Address	Stored in the consoles memory. Set at factory	None	None
Network Time Server 1	These addresses are set at the factory and will not need to be changed in the field.	None	None
Network Time Server 2	These addresses are set at the factory and cannot be changed in the field.	None	None
Network Time Server 3	These addresses are set at the factory and cannot be changed in the field.	None	None
Machine Type	Type of equipment (AMT, RBK, UBK, EFX, & TRM). Set at factory.	None	None

3. Touch ◀ BACK to Settings. Procedure 3.1.

## Procedure 3.3- P80 - Equipment Usage

Equipment Usage			
Menu or Information Item	Description	Navigation	Detail or Test
Cumulative Workout Seconds	Total number of seconds. Seconds are counted when the workout clock starts	None	None
Cumulative Workout Distance	<ul style="list-style-type: none"> <li>• Treadmills will report miles of use.</li> <li>• AMTs will report a horizontal distance as miles.</li> <li>• Ellipticals will convert total strides to miles.</li> <li>• Bikes will convert total revolutions to miles</li> </ul>	None	None
Cumulative Work Out Sessions	Total number of sessions. A session is counted if the summary screen displays.	None	None
Last Workout Start Date Time	The date of the start of the last workout.	None	None
Last Workout End Date Time	The date of the end of the last workout.	None	None

1. Refer to Procedure 3.1 - Settings to access the Equipment Usage menus.
2. The Equipment Usage settings provide information on individual usage as well as cumulative equipment usage. See Equipment Usage Table.
3. The Equipment Usage screen currently does not have additional detail or test screens.
4. Touch ◀ BACK to Settings. Procedure 3.1.

## Procedure 3.4 – P80– System Settings

1. Refer to Procedure 3.1 – Settings, to access the Equipment Usage menus.
2. Use the System Settings to test your equipment and set parameters that benefit your users and your facility.

System Settings			
Menu or Information Item	Description	Navigation	Configure/View/Test
Systems Test	The systems tests allow you to check specific functions of the equipment.	Touch Systems Test	See Procedure 3.6
Connectivity	The connectivity screens allow you to configure or provides information about the equipment's network connection.	Touch Connectivity	See Procedure 3.7
Display	The display settings allow you to configure, Measurement units, Standby Mode Delay, Time Zone, and Closed Captioning.	Touch Display	See Procedure 3.8
TV Settings	TV Settings help you set up television channels for your users.	Touch TV Settings	See Procedure 3.9
Work out Limits	The Workout Limit settings give you control over how the equipment is used. Use these settings to create reasonable limitations for equipment usage including speed, incline, resistance, and duration.	Touch Workout Limits	See Procedure 3.10
Manage Settings	Use this setting to save your equipment settings to a USB flash drive, or to import settings from a USB flash drive.	Touch Manage Settings	See Procedure 3.11 (Cloning)

## Procedure 3.5 – P80 – Updating Software

The P80 console is driven by software with innovative features which enhances the user's experience during a workout. Periodically the software will need to be updated with improvements to the functionality and features. Procedure will explain how to update the software at the customer's location using a USB Flash drive device for P80 consoles.

A USB Flash drive device with pre-loaded software or a web site location where you can upload the software onto a USB Flash drive device will be provided by PRECOR.

Procedure to update (Flash) software for P80 consoles:

1. The Welcome screen will be the first screen you see when you approach the P80 console. Press the Pause key and continue holding it down while you **double press** (prior to 1.1 version software release) or **single press** (1.1 version or after software release) in sequential order an X configuration on the Volume and Channel key pad (① Channel Up, ② Volume Down, ③ Volume Up, ④ Channel Down). See Diagram 3.1.1. Release the Pause key when done pressing the arrows. **Note: The keypad X configuration sequence should be not faster than 1 second between each key stroke.** Any speed faster than 1 second may result in an unsuccessful access to the sign-in screen.

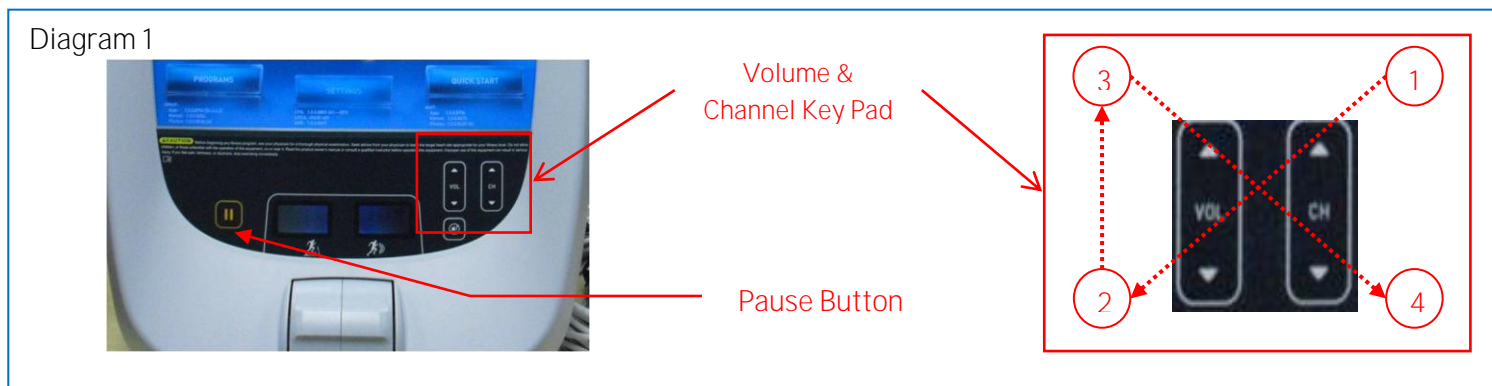

2. The sign-in screen will be displayed. Type in the technician access code and press enter.
3. Insert the USB Flash Drive into the USB Drive Port of the P80 console. See Diagram 2.



4. The P80 software will automatically access the USB Flash Drive files and look for a valid software update. While the USB Flash Drive is being validated, No Updates Available, will be displayed on the P-80 console screen. Once an update file has been identified and validated, Updates Available, will be displayed on the P-80 console screen. Touch the spot on the P80 console screen where Updates Available is displayed to select.
5. A software package or list of software packages will be displayed on the P80 console screen. Touch the spot on the P80 console screen displaying the software package required.

Note: PRECOR customer service will specify which software package is required when the service is requested to update P-80 Console software. If you are unsure of which software package should be installed, contact PRECOR customer service.

6. Touch the spot on the screen displaying Install and the P80 console will start the software installation process. The software installation process can take up to 35 minutes and the console will automatically reboot when it has finished.
7. Once the download as started it is safe to remove the USB Flash Drive device from the P80 USB port.
8. When the P80 has completed rebooting the Welcome screen will be displayed. The installation of the software update is now complete.
9. Verify the correct version of software has been installed. This can be found by accessing the main menu using the instructions provided in steps 1 and 2, then selecting About. The software version will be displayed under Installed Bundle Version and should match the package selected in step 5.

## Procedure 3.6- P80 - Systems Tests

1. Refer to Procedure 3.1 - Settings, to access the Equipment Usage menus.
2. The systems tests allow you to check specific functions of the equipment.
3. To select a Systems Test touch on an item in the Systems Test menu.

Systems Tests		
Test	Equipment	Description
Auto Stop Test	TRM Only	<ol style="list-style-type: none"> <li>1. Touch Auto Stop Test, then Touch START.</li> <li>2. The Auto stop test will start the belt at 1 mph; count will be reset to 0, and then count up with each step.</li> <li>3. Touch STOP to end the test. Touch ◀ BACK to exit to Systems Test.</li> </ol>
Belt Speed Test	TRM Only	<ol style="list-style-type: none"> <li>1. Touch Belt Speed Test, then Touch START.</li> <li>2. The belt will start a 0.5 mph, using the machine control paddle to increase by 0.1 mph increments. The console will display motor current as the belt speed increases or decreases.</li> <li>3. Touch STOP to end the test. Touch ◀ BACK to exit to Systems Test.</li> </ol>
Incline Test	TRM Only	<ol style="list-style-type: none"> <li>1. Touch Incline Test, and then Touch START.</li> <li>2. Use the machine control paddle to change the lift. The console will display the analog to digital (A/D) incline position number and the incline position in percent of incline.</li> <li>3. Touch STOP to end the test. Touch ◀ BACK to exit to Systems Test.</li> </ol>
AMT Stride Position Test	AMT Only	<ol style="list-style-type: none"> <li>1. Touch AMT Stride Position Test and then Touch START.</li> <li>2. The High, Low and Dynamic positions will be displayed. The low position display shows the lowest position reading achieved during the test. The high position display shows the highest position reading achieved during the test. The dynamic position display changes with current stride position. Stride on the AMT to the maximum horizontal movement in both directions. At maximum stride length the low stride display should read 0 and the high stride display should read 40.</li> <li>3. Touch STOP to end the test. Touch ◀ BACK to exit to System Tests.</li> </ol>
Brake Test	AMT, RBK, UBK, EFX	<ol style="list-style-type: none"> <li>1. Touch Brake Test, then Touch START.</li> <li>2. Use the machine control paddle to change the resistance up and down. The resistance changes will be displayed in power bits.</li> <li>3. Touch STOP to end the test. Touch ◀ BACK to Systems Test.</li> </ol>

Systems Tests Continued		
Battery Test	AMT, RBK, UBK, EFX	<ol style="list-style-type: none"> <li>1. Touch Battery Test, and then Touch START.</li> <li>2. The console will display the voltage of the battery.</li> <li>3. Touch STOP to end the test. Touch ◀BACK to Systems Test.</li> </ol>
SPM	AMT, EFX	<ol style="list-style-type: none"> <li>1. Touch SPM Test, and then START.</li> <li>2. The console will display Pulse. The pulse is showing a count of zero crossings from the generator. SPM shows a software averaged version of pulse. A averaged pulse per minute will display as Minimum and a Maximum pulse.</li> <li>3. Touch STOP to end the test. Touch ◀BACK to exit to Systems Tests.</li> </ol>
RPM Test	RBK, EFX	<ol style="list-style-type: none"> <li>1. Touch RPM Test, and then START.</li> <li>2. The console will display Pulse. The pulse is showing a count of zero crossings from the generator. RPM shows a software averaged version of pulse.</li> <li>3. Touch STOP to end the test. Touch ◀BACK to exit to Systems Test.</li> </ol>
CrossRamp	EFX Only	<ol style="list-style-type: none"> <li>1. Touch CrossRamp Test , and then Touch START.</li> <li>2. Use the machine control paddle to change the CrossRamp. The console will display the analog to digital (A/D) and Glitches incline position number. Available battery voltage to the lift system will be displayed.</li> <li>3. Touch STOP to end the test. Touch ◀BACK to Systems Test.</li> </ol>
USB Test	All	<ol style="list-style-type: none"> <li>1. Touch USB Test.</li> <li>2. The USB Test will show the number of USB ports currently active, there should be six. Insert a USB Flash drive into the USB port and then Touch CLOSE, and then Touch USB Test again. The number of active USB ports should be increased by one.</li> <li>3. Touch CLOSE to exit to Systems Test.</li> </ol>
Touchscreen Test	All	<ol style="list-style-type: none"> <li>1. Touch Touchscreen Test.</li> <li>2. Place your finger on one corner of the screen and run it around the edges multiple times.</li> <li>3. The line drawn by your finger should be very close to previous passes. Be sure that you do not touch anything else with your other hand.</li> <li>4. Touch FINISH to exit to Systems Test.</li> </ol>

Systems Tests Continued		
Touchscreen Calibration	All	<ol style="list-style-type: none"> <li>1. Touch Touchscreen Calibration.</li> <li>2. A + will be displayed on a white screen. Touch the +, the spot you just touched will disappear and then be replaced with another + in a different location on the white screen.</li> <li>3. Continue to touch the + as they appear on the screen until the test automatically exits to the Systems Test screen. You cannot exit this test until all the + have been touched and the screen is calibrated.</li> </ol>
Backlight Test	All	<ol style="list-style-type: none"> <li>1. Touch Backlight Test</li> <li>2. The backlight will display three levels of brightness, 100%, 60%, and 0% in succession in 1 second intervals, returning to the System Tests menu when complete.</li> </ol>
RGB Test	All	<ol style="list-style-type: none"> <li>1. Touch RGB Test.</li> <li>2. The full screen should move through a succession of five colors, requiring a touch anywhere on the screen to advance to the next. These are <b>Red, Green, Blue, Black, White</b>, returning to the Systems Tests menu when all the displayed colors have been touched.</li> </ol>
Speaker Test	All	<ol style="list-style-type: none"> <li>1. Touch Speaker Test.</li> <li>2. This test will send an audible sound to the speaker mounted in the headphone jack and while providing a graphic of a scrolling bar on the screen. When the test is complete it will automatically exit to the Systems Test screen.</li> </ol>
Numeric Backlight Test	All	<ol style="list-style-type: none"> <li>1. Touch Numeric Backlight Test.</li> <li>2. This tests the back lights of the lower display just above the paddle controls. The back lights of the display will illuminate in sequence and then automatically exit to the Systems Test screen.</li> </ol>
Numeric Display Test	All	<ol style="list-style-type: none"> <li>1. Touch Numeric Display Test.</li> <li>2. This will test the numeric LCD display just above the paddle controls. All the numeric characters will be displayed in sequence and then automatically exit to the Systems Test.</li> </ol>
Heart Rate	All	<ol style="list-style-type: none"> <li>1. Touch Heart Rate.</li> <li>2. Grasp both of the heart rate grips on the handlebar, after a couple of seconds the heart rate will be displayed.</li> <li>3. Touch ◀ BACK to exit to Systems Test.</li> </ol>

3. Touch ◀ BACK to Settings. Procedure 3.1.



## Procedure 3.7 – P80- Connectivity

Configuring your audio, video, and network infrastructure requires expertise. Precor strongly recommends that you work with a qualified contractor to set up this infrastructure.

This setting provides the following information:

- Network Type
  - Wired (Default)
  - Wireless (This is a selectable option but is not currently supported)
- Configuration
- Status
- IP Address
- Preva Server

To view connectivity information:

1. Refer to Procedure 3.1 – Settings, to access the Connectivity menus.
2. To select a Connectivity Setting touch on an item in the Connectivity Settings menu.

Connectivity settings		
Settings	Default	Detail
Network Type	Wired	
Configuration	Automatic	Automatic (DHCP) or Manual (Static IP)  Press Network Settings to view the <ul style="list-style-type: none"> <li>• IP Address</li> <li>• Netmask</li> <li>• Gateway</li> <li>• DNS Primary</li> <li>• DNS Secondary</li> </ul>
Status	N/A	<ul style="list-style-type: none"> <li>• Connected –Connected to the network.</li> <li>• Not Connected - Not connected to the network</li> </ul>
IP Address	N/A	Location-specific
Preva Server		na.preva.precor.com

## Connectivity Set Up and Registration Procedure

1. Before you attempt to connect to the Precor Preva Server, check the status field and ensure that the Connected is displayed. If the Status field shows Not Connected, you will need to diagnose your networking issue. Continue with Step 2. If the Status Field shows Connected go to step 3. See Diagram 3.7.1
2. Either the Ethernet cable is not connected or there is a problem with the network connection. Check the connection and then check the Status field again. If the Status field shows Connected continue with step 3. If the Status field still shows Not Connected contact your IT expert.

Diagram 3.7.1

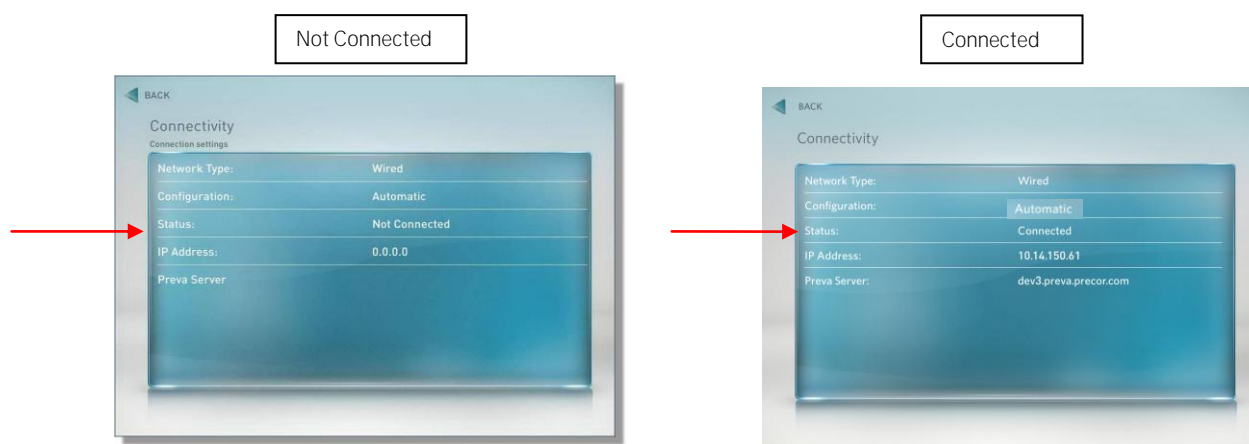

3. Check the IP Address field for a valid IP Address. If the IP Address is present continue with step 12. If the IP Address is not present continue with step 4. See Diagram 3.7.2.

Diagram 3.7.2

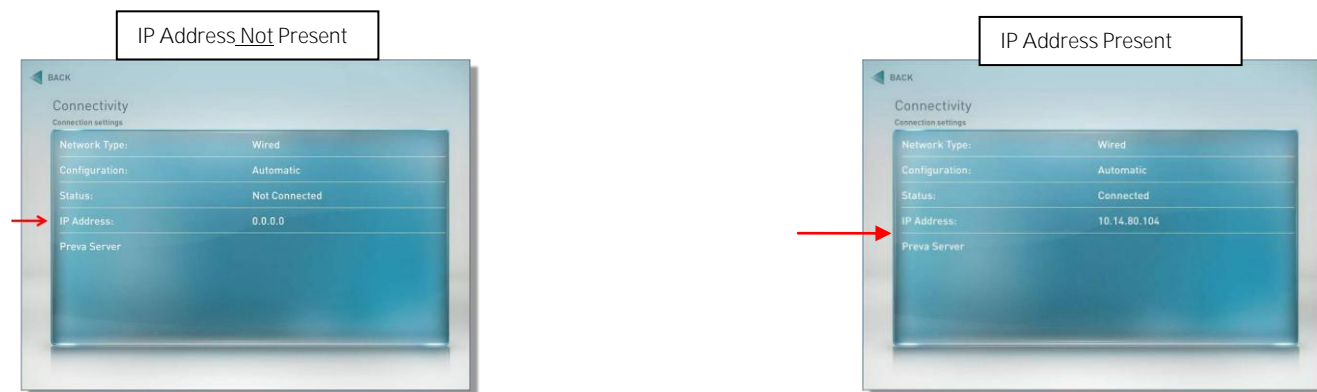

- If the Status shows Connected and the IP Address is not present, it will be necessary to either have the P80 software assist in acquiring the IP Address (Recommended) or enter the IP address manually. Touch Configuration from the Connectivity menu.
- Touch on the radio button next to Automatic, and then touch SETTINGS. See Diagram 3.7.3.

Diagram 3.7.3

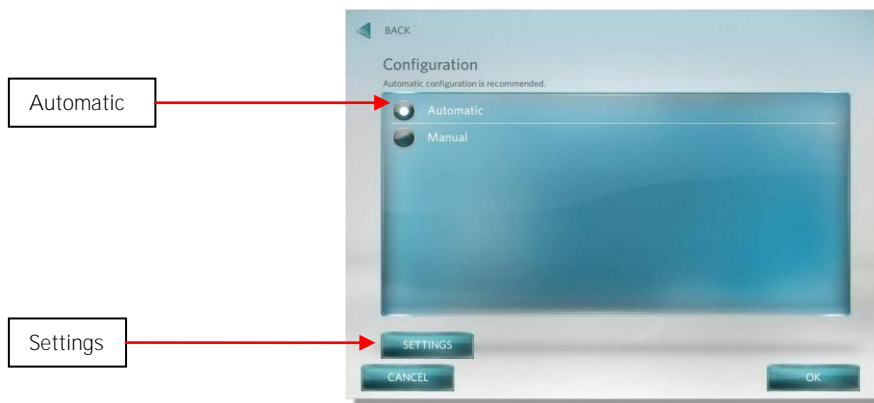

- The P80 will attempt to connect to the network, and when successful will acquire the networking information necessary for registration. If the console was already connected, it will skip straight to the 'Network Settings' screen and display the current network information. Once a good IP Address has been acquired, the P80 can now be registered. Continue with step 12.
- Note: Manually setting up the network configuration is not recommended. Precede with the following procedure only with assistance from the facilities IT staff. Touch Configuration from the Connectivity menu.
- Touch on radio button next to Manual, and then touch SETTINGS. See Diagram 3.7.4.

Diagram 3.7.4

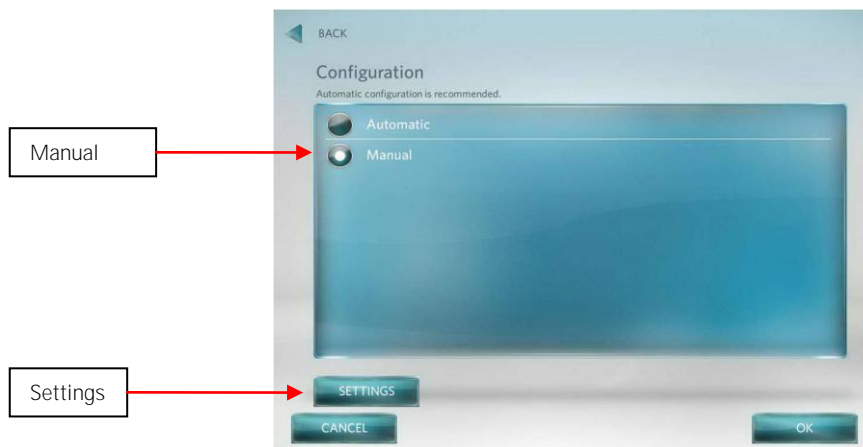

- Touch one of the network settings items from the Connectivity menu.
- Enter the data acquired from the network administrator using the on-screen key pad, and then select OK. See Diagram 3.7.5.
- Repeat steps 9 and 10 for the remaining network settings.

Diagram 3.7.5



12. Once a good IP Address is displayed, touch Preva Server to enter the web address.
13. If you are in North America enter na.preva.precor.com by using the on-screen keypad.
14. Touch OK.
15. A screen will appear stating, The equipment is ready to be set up, touch USER NAME AND PASSWORD.
16. The user name and password will have been provided by Precor prior to installation. Enter the user name using the on-screen keypad, then touch NEXT.
17. Enter the password using the on-screen keypad, then touch NEXT.
18. The next screen will list information that you need to know before continuing with the registration process.
  - Site Code
  - Base Serial Number
  - Friendly Name

Site Code – This is given at the time of the dispatch.  
 Base Serial – The base serial number is located on the exercise equipment.  
 Friendly Name - It is recommended that you have a list of the equipment with friendly names already assigned, such as Elliptical 1, Treadmill 22, and so forth. Touch NEXT.
19. Enter the Site Code using the on-screen keypad, then touch NEXT.
20. Enter the Base Serial Number using the on-screen keypad, then touch NEXT.
21. Enter the Friendly Name using the on-screen keypad, then touch NEXT.
22. The next screen displayed will be the Registration Summary screen. Review the screen to ensure the information entered is correct before completing the registration. If the information is not correct touch ◀ BACK until the screen with incorrect information is displayed. Make the corrections and then touch NEXT unit you are back at the Registration Summary Screen.
23. Touch Register to submit the data.
24. If the registration was successful a screen with current software version will be displayed. Touch FINISH to the Systems Settings menu, if a newer software version is available, the console will automatically start the download.
25. Touch ◀ BACK to Settings. Procedure 3.1.

## Procedure 3.8 – P80- Display

The display settings allow you to configure Measurement units, Standby Mode Delay, Time Zone, and Closed Captioning.

1. Refer to Procedure 3.1 – Settings, to access the Display menus.
2. To select a Display Settings touch on an item in the Display menu.

Display			
Settings	Settings Options	Default Fault	Configure/View/Test
Language	<ul style="list-style-type: none"> <li>• German</li> <li>• English</li> <li>• Spanish</li> <li>• French</li> <li>• Italian</li> <li>• Dutch</li> <li>• Russian</li> <li>• Japanese</li> </ul>	English	<ol style="list-style-type: none"> <li>1. Touch Language</li> <li>2. Touch on a radio button next to the desired language, a dot will fill the radio button next to the selection.</li> <li>3. Touch OK or CANCEL to exit to the Display menu.</li> </ol>
Measurement Units	US Standard or Metric	US Standard	<ol style="list-style-type: none"> <li>1. Touch Measurement Units</li> <li>2. Touch on a radio button next to either US Standard or Metric; a dot will fill the radio button next to the selection.</li> <li>3. Touch OK or CANCEL to exit to the Display menu.</li> </ol>
Standby Mode Delay	<ul style="list-style-type: none"> <li>• 5 Minutes</li> <li>• 15 Minutes</li> <li>• 30 Minutes</li> <li>• 60 Minutes</li> </ul>	15 Minutes	<ol style="list-style-type: none"> <li>1. Touch Standby Mode Delay.</li> <li>2. Touch on a radio button next to the desired delay time, a dot will then fill the radio button.</li> <li>3. Touch OK or CANCEL to exit to the Display menu.</li> </ol>
Time Zone	GMT- 12 through GMT + 12	GMT - 00-10	<ol style="list-style-type: none"> <li>1. Touch Time Zone.</li> <li>2. Touch on the radio button next to the desired Time Zone, a dot will fill the radio button.</li> <li>3. Touch OK or CANCEL to exit to the Display menu.</li> </ol>
Closed Captioning	ON/OFF	ON	<ol style="list-style-type: none"> <li>1. Touch Closed Captioning</li> <li>2. Touch on a radio button next to either ON/OFF, a dot will fill the radio button next to the desired selection.</li> <li>3. Touch OK or CANCEL to exit to the Display menu.</li> </ol>

4. Touch ◀ BACK to Settings. Procedure 3.1.

## Procedure 3.9 – P80- TV Settings

The display settings allow you to configure Measurement units, Standby Mode Delay, Time Zone, and Closed Captioning.

1. Refer to Procedure 3.1 – Settings, to access the TV Settings menus.
2. To select a TV Settings setting, touch on an item in the TV Settings menu.

The TV Settings are:

- Channel Guide
- Region
- Default Channel
- Skip Unnamed Channels

Settings	Default	Detail
Channel Guide		Scan Channels
Region	United States	Select the appropriate region for your location.
Default Channel		Set a default channel for the equipment. This is the channel that will display when the TV is turned on.
Skip Unnamed Channels	On	ON/OFF

### Channel Guide

The following procedure discusses how to set up the channel guide and how to configure audio and video playback.

Note: The correct region must be set before you scan for available channels. To confirm the settings, touch Region, a list of regions will be displayed. Confirm that the radio button next to the appropriate region for your area is selected. If the highlighted region is incorrect, touch on the radio button next to appropriate region. Touch OK, and then touch ◀ BACK to the TV Settings menu.

To scan for available channels:

1. Touch Channel Guide from the TV Settings menu.
2. Touch Scan Channel.

The console scans for available channels and when the scan is finished all available channels will be displayed on the screen.

To delete a channel from the Channel Guide:

1. On the Channel Guide screen, touch the listing for the channel you want to delete.
2. Touch the DELETE button.
3. When asked Are you sure? verify that you want to proceed, then touch YES.
4. Touch ◀ BACK to Settings. Procedure 3.1.

## Procedure 3.10- P80 – Workout Limits

The Workout Limit settings give you control over how the equipment is used. Use these settings to create reasonable limitations for equipment usage including speed, incline, resistance, and duration.

1. Refer to Procedure 3.1 – Settings, to access the Workout Limits menus.
2. To select a Workout Limits setting, touch on an item in the Workout Limits menu.

Workout Limits Settings			
Settings	Settings Options	Default Fault	Configure/View/Test
Maximum Workout Duration	Use the on-screen keypad or the up and down arrows to enter the maximum workout duration allowed on this fitness equipment.	60 minutes	<ol style="list-style-type: none"> <li>1. Touch Maximum Workout Duration</li> <li>2. The on-screen keypad will appear, enter the desired duration using the keypad. If an error was made while typing in the duration number, press the back space key ◀ key on the keypad to delete the last entry. Touching the ◀ also reactivate the presets after typing a number on the keypad.</li> <li>3. Touch FINISH to exit to the Workout Limits screen.</li> </ol>
Maximum Pause Time	<ul style="list-style-type: none"> <li>• 1 second</li> <li>• 5 seconds</li> <li>• 15 seconds</li> <li>• 30 seconds</li> <li>• 60 seconds</li> <li>• 120 seconds</li> <li>• 300 seconds</li> </ul>	30 seconds	<ol style="list-style-type: none"> <li>1. Touch Maximum Pause Time.</li> <li>2. Touch on a radio button next to the desired time, a dot will then fill the radio button next to the selection.</li> <li>3. Touch OK to exit to the Workout Limits Settings menu.</li> </ol>
Summary Time Out	<ul style="list-style-type: none"> <li>• No Time Out</li> <li>• 30 seconds</li> <li>• 60 seconds</li> <li>• 120 seconds</li> </ul>	60 seconds	<ol style="list-style-type: none"> <li>1. Touch Summary Time Out.</li> <li>2. Touch on a radio button next to the desired time, a dot will then fill the radio button next to the selection.</li> <li>3. Touch OK to exit to the Workout Limits Settings menu.</li> </ol>

Workout Limits Settings Continued			
Settings	Settings Options	Default Fault	Configure/View/Test
Resistance Range (RBK, UBK only)	<ul style="list-style-type: none"> <li>Low</li> <li>Medium</li> <li>High</li> </ul>	Medium	<ol style="list-style-type: none"> <li>Touch Resistance Range</li> <li>Touch on the radio button next to Low, Medium, or High, a dot will fill the radio button next the selection.</li> <li>Touch OK to exit to the Display menu.</li> </ol>
Speed Limit (TRM only)	1-16 mph	16 mph	<ol style="list-style-type: none"> <li>Touch Speed Limit</li> <li>The on-screen keypad will appear, enter the desired duration using the keypad.</li> <li>Touch FINISH to exit to the Workout Limits screen.</li> </ol>
Incline Limit (TRM only)	TRM 883 CrossRamp incline range can be set to 0%-15%.  TRM 885 CrossRamp incline range can be set to 0% to 15% Note: the incline range is -3% to 15% but the limit can only be set from 0% to 15%	15	<ol style="list-style-type: none"> <li>Touch Incline Limit</li> <li>The on-screen keypad will appear, enter the desired duration using the keypad.</li> <li>Touch FINISH to exit to the Workout Limits screen.</li> </ol>
Auto Stop (TRM only)	<ul style="list-style-type: none"> <li>ON</li> <li>OFF</li> </ul>	ON	<ol style="list-style-type: none"> <li>Touch Auto Stop</li> <li>Touch on a radio button next to either ON/OFF, a dot will then fill the radio button next to the selection.</li> <li>Touch OK to exit to the Workout Limits menu.</li> </ol>
CrossRamp Auto Level (EFX only)	CrossRamp Auto level settings are from 1% to 20%	1	<ol style="list-style-type: none"> <li>Touch CrossRamp Auto Level</li> <li>Touch the ▲, ▼ to move auto level to the desired setting.</li> <li>Touch OK to exit to the Workout Limits menu.</li> </ol>

3. Touch ◀ BACK to Settings. Procedure 3.1.



## Procedure 3.11 – P80 – Manage Settings (Cloning)

The only P80 console settings that can be imported and exported through a USB Flash Drive device at this time are:

Settings that Can Be Cloned	
Menu	Settings
Display	<ul style="list-style-type: none"> <li>• Measurement of Units</li> <li>• Standby Mode Delay</li> <li>• Time Zone</li> <li>• Closed Captioning</li> <li>• Language</li> </ul>
Workout Limits	<ul style="list-style-type: none"> <li>• Maximum Workout Duration</li> <li>• Maximum Pause Time</li> <li>• Summary Time Out</li> <li>• Resistance Range (RBK, UBK only)</li> <li>• Speed Limit (TRM only)</li> <li>• Incline Limit (TRM only)</li> <li>• Auto Stop (TRM only)</li> <li>• CrossRamp Auto Level (EFX only)</li> </ul>
TV Settings	<ul style="list-style-type: none"> <li>• Channel Guide</li> <li>• Region</li> <li>• Default Channel</li> <li>• Skip Unnamed Channels</li> </ul>
Network Settings	<ul style="list-style-type: none"> <li>• Primary DNS - Manual only</li> <li>• Secondary DNS - Manual only</li> <li>• Gateway - Manual only</li> <li>• Netmask - Manual only</li> </ul>
Connectivity	<ul style="list-style-type: none"> <li>• Network Type</li> <li>• Preva Server Address</li> </ul>

The following procedure will explain how to save existing P80 console settings onto a USB Flash Drive and then import the saved settings into another P80 console.

Note: Settings from one P80 console will need to be configured manually and imported to a flash drive device before cloning and exporting to additional P80 consoles.

### Procedure

1. The Welcome screen will be the first screen you see when you approach the P80 console. Press the Pause key and continue holding it down while you **double press** (prior to 1.1 version software release) or **single press** (1.1 version or after software release) in sequential order an X configuration on the Volume and Channel key pad (① Channel Up, ② Volume Down, ③ Volume Up, ④ Channel Down). See Diagram 3.1.1. Release the Pause key when done pressing the arrows. **Note: The keypad X configuration sequence should be not faster than 1 second between each key stroke.** Any speed faster than 1 second may result in an unsuccessful access to the sign-in screen.

Diagram 3.11.1

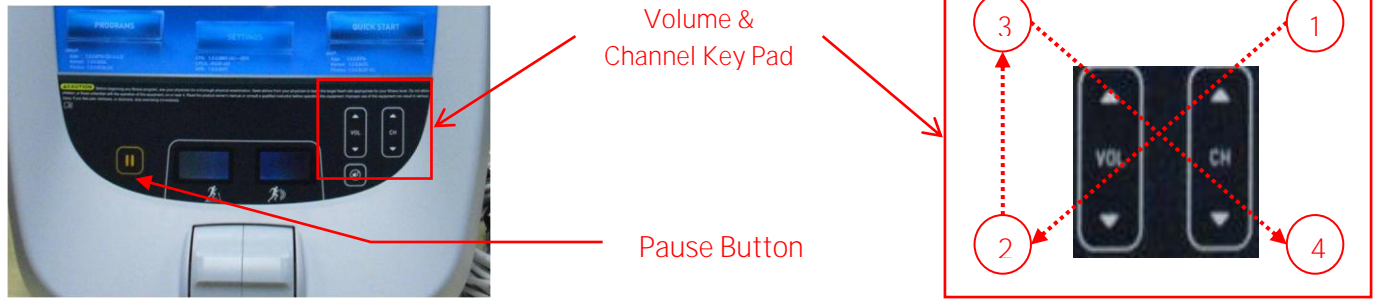

2. The sign-in screen will be displayed. Type in the technician access code and press enter.
3. The Settings screen will be displayed. Select Systems Settings from the Settings menu.
4. From the Systems Settings menu select Manage Settings.
5. The Manage Settings screen will display two gray inactive USB Flash Drive Icons. See Diagram 3.11.2.

Diagram 3.11.2



6. Insert the USB Flash Drive into the USB Drive Port of the P80 console. See Diagram 3.11.3.

Diagram 3.11.3



7. When the gray inactive Save to USB Flash Drive Icon becomes active and lights up, select Save to USB. See Diagram 3.11.4

Note: Depending on the type of Flash Drive device used, it may take up to a minute for the USB Flash Drive Icons to become active (light up) after the USB Flash Drive device has been inserted into the P80 console.

Diagram 3.11.4



8. You will see a scrolling in process bar and then Settings exported successfully to the USB drive displayed. See Diagram 3.11.5
9. Touch OK to return the Settings menus.

Diagram 3.11.5



10. The settings export is now complete and you can exit the service mode by touching the back arrow until you get to the Welcome screen.
11. Move the USB Flash Drive device with the saved settings to a P80 console that you would like to import the saved settings.
12. Access the Manage Settings screen by following the described steps 1 through 9.
13. Insert the USB Flash Drive into the USB Drive Port of the P80 console. See Diagram 3.11.3.
14. Wait for the USB Flash Drive Icons to become active (light up) and then select Import from USB. See Diagram 3.11.6

Diagram 3.11.6



15. You will see a scrolling in process bar and then Settings imported successfully displayed. See Diagram 3.11.7
16. Touch OK to return the Settings menus.

Diagram 3.11.7



17. Exit the service mode as described in steps 14.
18. Repeat the described process steps 11 through 16 for any remaining P80 consoles.

## Procedure 3.12 - P80 - Replacing the Console

### Required Tools

- 2- 7/16 in open end wrenches
- 1/4-inch hex wrench
- SAE 5/32-inch hex wrench
- SAE 1/2-inch box-end wrench
- #2 Phillips screwdriver
- Wire cutter

### Procedure

1. Remove the rear vent cover. Do not use a sharp tool, such as a flat bladed screwdriver, to pry up the cover, as you can damage the covers and possibly components inside the console. When the cover starts to come loose, gently unsnap it from the P80 and set it aside where it will not be scratched. See Diagram 3.12.1

Diagram 3.12.1

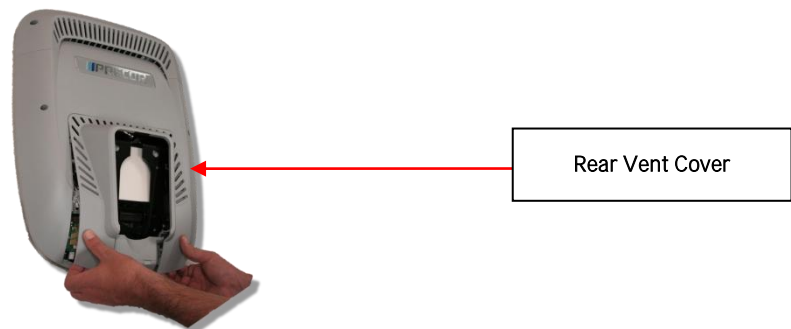

2. Remove the four flat head 5/8 inch long screws that secure the console to the plate. See Diagram 3.12.2

Diagram 3.12.2

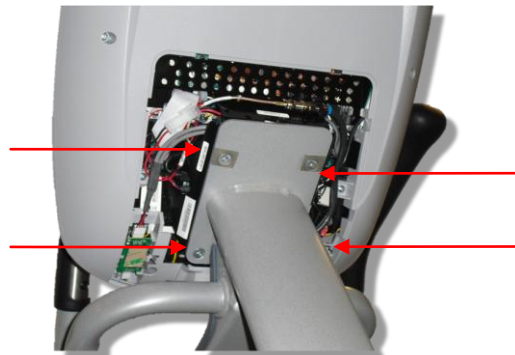

3. Tilt the console forward (away from yourself) on the mounting hook. See Diagram 3.12.3

Diagram 3.12.3

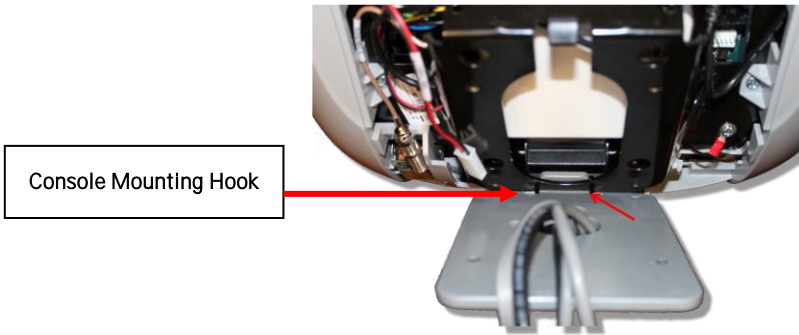

4. Locate the coax connector and cut the wire tie that secures the coax connector to the console armor. Disconnect the coax cable connector from the consoles flexible coax cable connector. See Diagram 3.12.4

Diagram 3.12.4

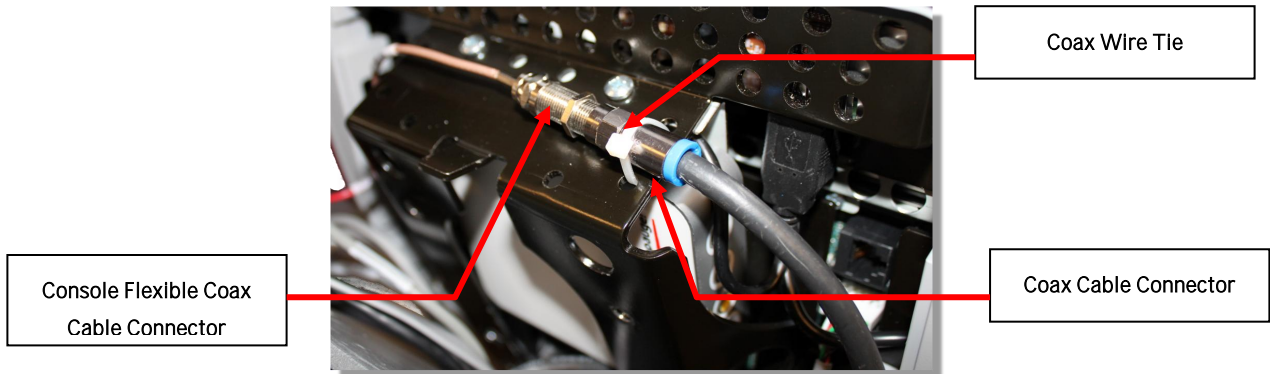

5. Disconnect the Ethernet cable, Data cable, the Power cable and the HR cable. See Diagram 3.12.5

Diagram 3.12.5

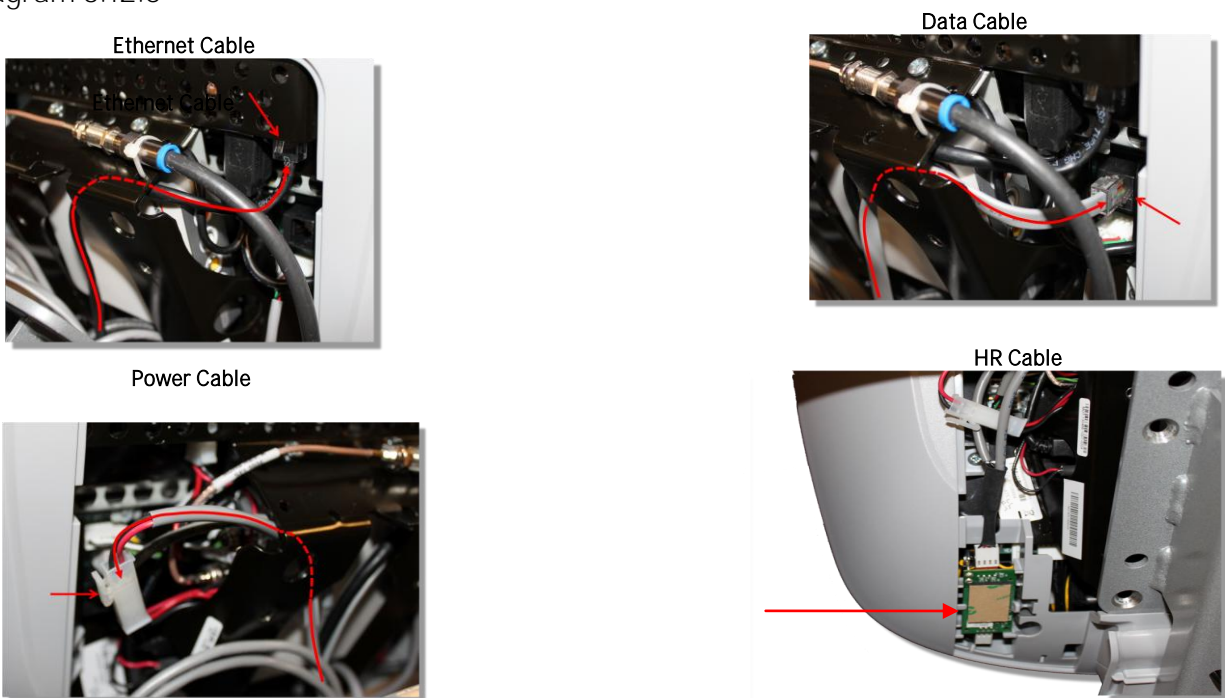

6. Remove the console by lifting it off the mounting hook.
7. Install the replacement console. In the back of the P80 console there is a large black steel support called the Armor. At the bottom of Armor there is a notch about ¼ inches in depth and about 1½ inches across. See Diagram 3.12.6. Set the console notch over the over the mounting hook. Note: Before releasing the console insure the notch is securely seated over the mounting hook. See Diagram 3.12.4

Diagram 3.12.6

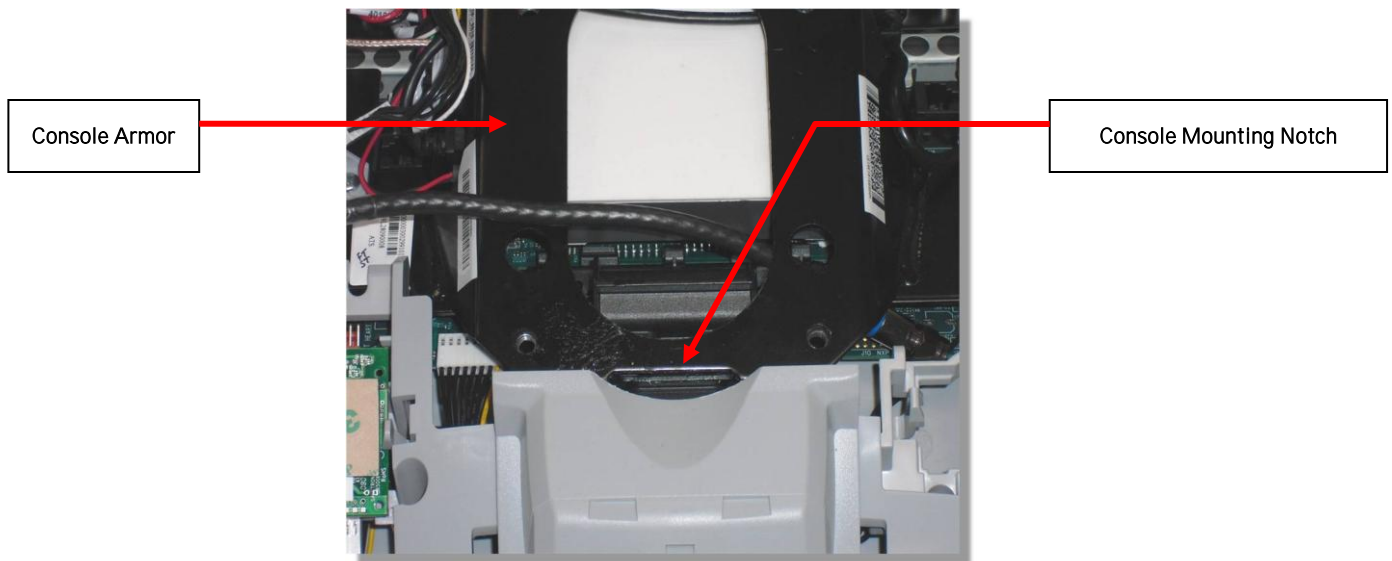

8. Route the RF coax cable down below the tuner and out the right bottom side of the armor. This is easier if you straighten the cable and gently push it in the direction as shown in diagram 3.11.7. Feed about 10 inches of cable out though the plastic using your finger as a guide.
9. Bring the coax cable up over the top of the armor and connect it to the flexible cable attached to the tuner. See Diagram 3.12.8.
10. Secure the RF coax connectors in place with a zip tie. Note: It is important that the connection be tied to the frame in this location to prevent the cable from being pinched, and the possibility of rattling noises during use. Be sure to secure the zip tie on the connector and not on the cable. See Diagram 3.12.9.

Diagram 3.12.7

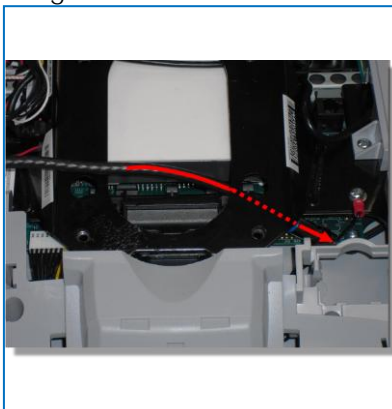
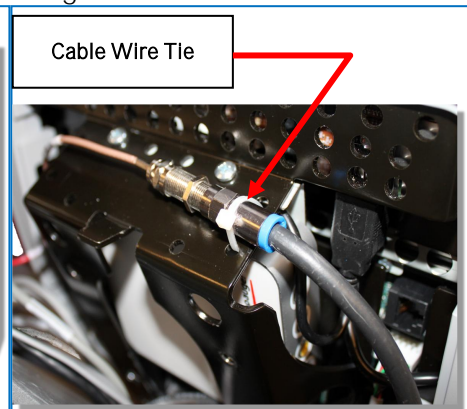

Diagram 3.12.8



Diagram 3.12.9



11. Route the black, round Ethernet cable through the opening in the upper right side of the armor, behind the tuner and connect the Ethernet cable to the upper RJ45 type connector. See Diagram 3.12.10.
12. Route the grey, flat Data cable through the opening in the upper right side of the armor, behind the tuner and connect the Data cable to the lower RJ45 type connector. See Diagram 3.12.11.

Diagram 3.12.10

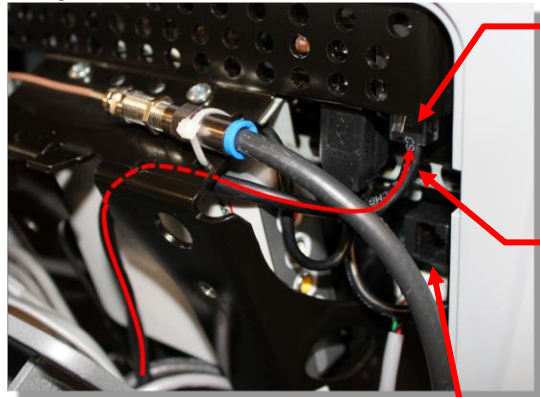
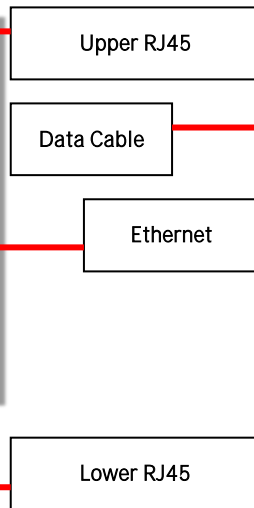
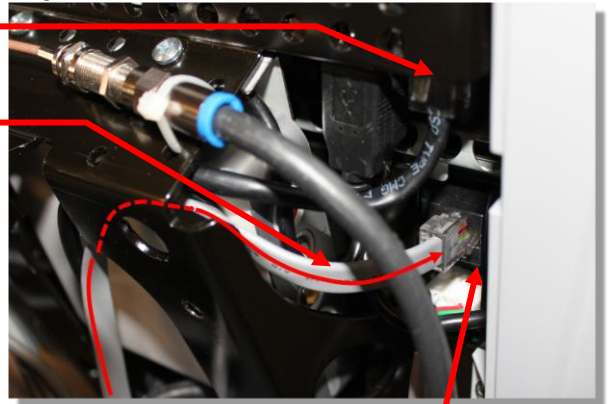
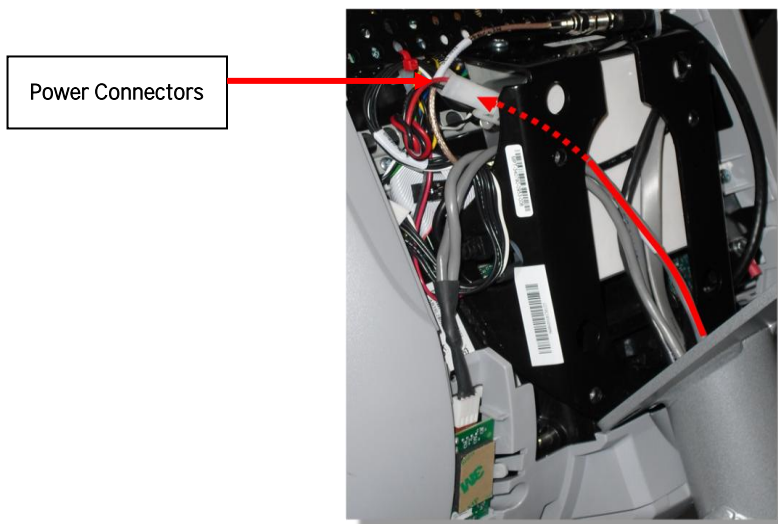

Diagram 3.12.11



13. Route the Power cable through the upper left corner of the weldment and connect it to the P80 power connector. See Diagram 3.12.12. Note: Leave the connector on the side of the P80 as shown in diagram 3.12.12, as it might be necessary to access it for troubleshooting.

Diagram 3.11.12



14. Route the Heart Rate cable through the upper left corner of the weldment and connect it to the HR PCA. Route any excess Heart Rate cable into the rectangular center section of the dash assembly. See Diagram 3.12.13



Diagram 3.12.13

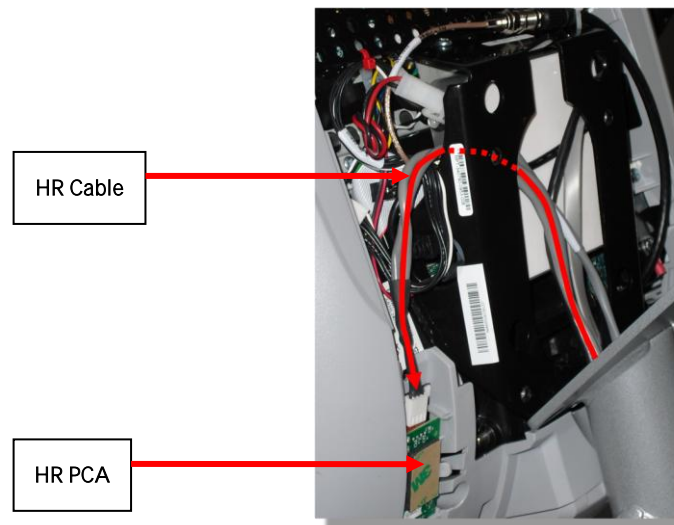

15. Make sure that all cables are fully and securely connected, and that cables are tied back properly. Make sure any extra cabling is pulled down through the neck and along the front of the dash, making sure the cables are routed through the plastic guides inside the neck.
16. Tilt the control console backward (toward yourself) until the tab on the top edge of the armor slides along the top edge of the console mount and the screw holes align properly.
17. Secure the console to the plate using the four flat head  $\frac{5}{8}$  inch long screws. Note: You must use  $\frac{5}{8}$  inch long screws. If the screws are too short the console will not be properly grounded. If the screws are too long it is possible to damage the internal wiring.
18. Tighten the screws fully using a  $\frac{5}{32}$ -inch hex wrench.
19. Replace the rear vent cover.

## Procedure 3.13 – P80 – Replacing the Heart Rate PCA Board

### Procedure

20. Remove the rear vent cover. Do not use a sharp tool, such as a flat bladed screwdriver, to pry up the cover, as you can damage the covers and possibly components inside the console. When the cover starts to come loose, gently unsnap it from the P80 and set it aside where it will not be scratched. See Diagram 3.13.2

### Diagram 3.13.2

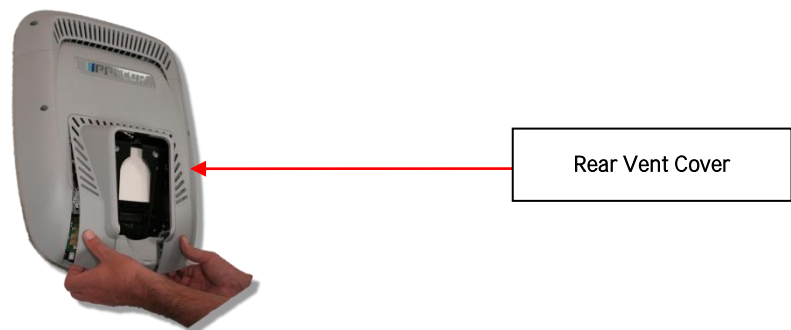

21. The PCA's in the console are static sensitive. They can be damaged if proper static prevention equipment is not used. Attach an anti-static wrist strap to your arm, and then connect the ground lead of the wrist strap to frame ground.
22. The HR PCA snaps into its mounting. Press the release tab sideways and remove the HR PCA from its mounting.
23. Disconnect the HR cable and handlebar cable from the HR PCA. See Diagram 3.13.3.
24. Connect the HHR Grip cable assembly to the upper connector on the HR PCA and the HR PCA Power cable to the lower connector on the replacement HR PCA. See Diagram 3.13.3.
25. Orient the replacement HR PCA so that the side with the protective foam pad is facing out and snap the HR PCA into its mounting.

Diagram 3.13.3

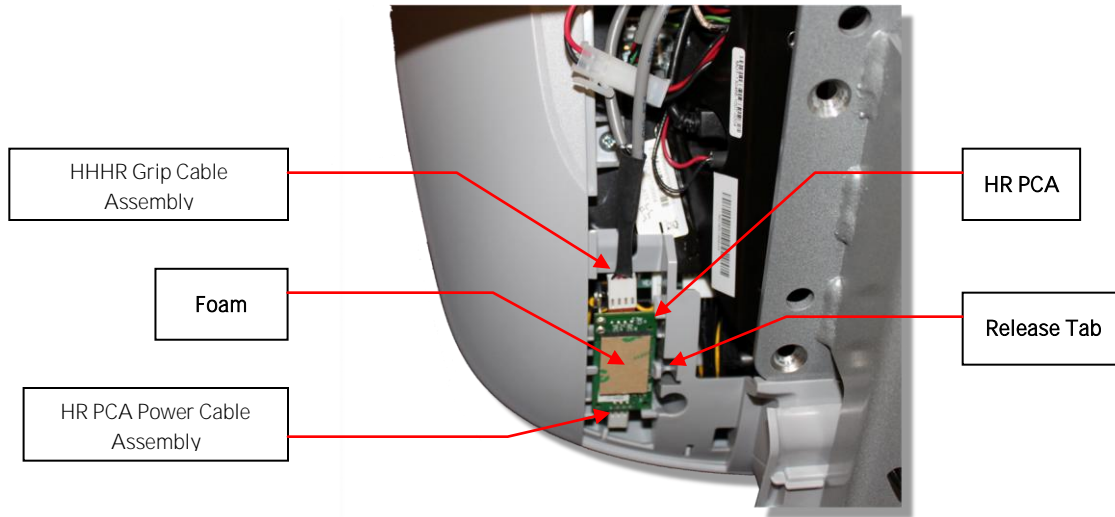

- 26. Replace the rear vent cover.
- 27. Check operation per Section 7.

Procedure 3.14 - P80- Future Content

Procedure 3.15 - P80- Future Content

Procedure 3.16 - P80- Future Content

Procedure 3.17 - P80- Future Content

Procedure 3.18 - P80- Future Content

Procedure 3.19 - P80- Future Content

## Troubleshooting 3.20- P80 - Black Screen - TV Only

### Description

The console interface and the fitness equipment operates normally when using workout programs, but TV channels only display as a black screen and audio is not present.

### Possible Causes

1. There is no TV signal to the console
  - a. External jumper cable is damaged or disconnected
  - b. Coax cables inside the unit are damaged or disconnected
  - c. All cables are good and connected but there is no signal at the drop
2. TV channel is not being received or is not a valid channel
3. USB cable connecting tuner to screen is loose or plugged in incorrectly
4. Media player has failed (software)
  - a. Watchdog may or may not be recovering the media player automatically
5. There may be a software mismatch between the CPA and the MFE.
6. Tuner has failed (hardware).

Diagram 3.20.1

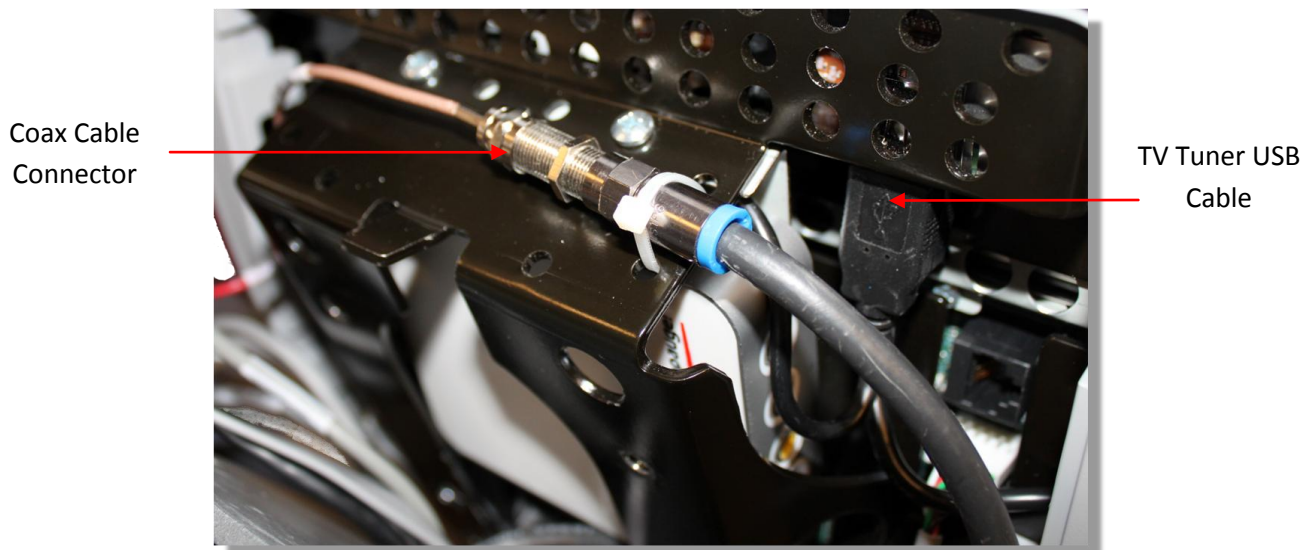

## Possible Remedies

1. Check for video signal to the tuner
  - a. Inspect jumper cables connecting fitness equipment to the video drop. If it is visibly damaged or disconnected, replace or reconnect. If it passes visual inspection, swap with a known good. If TV channel now appears, the cable is the cause. Replace the jumper cable. If the channel does not appear, perform the same check on the F connectors.
  - b. Inspect the cable that runs from the patch panel at the bottom of the machine to the console. If this is disconnected or damaged, reconnect or replace. If the cable passes visual inspection, use a known good cable to bypass this cable. If the TV channel appears, replace the coax cable running through the machine.
  - c. Connect the machine to a known good A/V drop. If the TV channel now appears on the console, verify the drop is good. If not, have the customer contact their A/V service technician to repair the drop. Getting a signal strength reading can assist in diagnosing the video problem.
2. Verify on other machines that this is a valid channel. If a channel would appear as total snow or static (as on a channel that is has no signal), then the console will display this as a black screen for that channel. If no machines receive this channel, it is likely that it is not a valid channel. The club's channel lineup may have changed or something may be wrong with their head end.
  - a. If the lineup has changed, rescan to pick up the correct channel lineup. If other units in the facility also have the incorrect lineup, you will need to export this new scan information to the other units.
3. Inspect the black USB cable running from the left side of the tuner to the USB jacks on the right side of the console. The tuner cable must be plugged into the correct jack. If it is not plugged into the outermost jack (the one closest to you when looking at the back of the console) plug it into the correct jack. See Diagram 3.20.1
4. If the signal to the console is good and the TV screen has been black for more than 5-10 minutes, then the watchdog is not able to recover the media player. If it is less than 5 minutes or so, the watchdog may still be trying to automatically recover the system.
  - a. This can be verified by looking in the Event Log. Messages that indicate a media reboot include: Rebooting the meda , The mediaapp restart is near, i2c timeout, or The OMAP board was rebooted because the mpaqtapp was not running, though this is not inclusive of all possible messages.
  - b. Rebooting the machine will force the media player to reboot. If the TV channel appears after rebooting, the issue was the media player. Verify all channels and operation of unit. If the channel is still black, then verify all other components are operational.
5. Some older versions of software can experience a bug where only one component reverts back to a different image. If the old image is of a much older version of software, this could cause some communications problems between the CPA and the MFE. Open the Settings menu and select Reflashing. Check the version numbers in the CPA Reflashing and the MFE Reflashing menus to make sure they are the correct version numbers. If they are not or say <UNKNOWN>, then this bug may have occurred. Try rebooting the unit to see if it resolves the issue. If not, use the appropriate Reflashing menu to boot that component to the other boot image. Verify that the new image contains the correct software versions.
6. If the video signal can be verified up to the tuner, connect a known good signal directly into the mini-coax on the tuner. If the channel lineup on the console has been confirmed correct, the signal is good, the unit has been rebooted, the software is correct on all components, and the screen is still black, the tuner has likely failed. Replace the entire console.

## Troubleshooting 3.21- P80 - Black Screen – Full Console

### Description

Console displays only a black screen. Machine is unusable.

### Possible Causes

1. Console has frozen
2. Console is attempting to boot to an image that has corrupted
3. Touch screen has failed

### Possible Remedies

1. Reboot the machine to resolve any software freezing issues.
2. If the console is attempting to boot to a corrupted software image, when a reboot is performed, the CPA version number will scroll across the display of the machine controls, but the screen will remain black and will never reach the Precor splash screen. Perform a 7 Power Cycle (See Boot Screen Procedure below) to force the machine to revert to the backup image. When the unit boots successfully, reflash the unit with the correct software to ensure that the old, corrupted image has a usable image installed.
3. If the touch screen has failed, the entire console will need to be replaced.

### Boot Screen Procedure

1. Turn the power off then back on. On treadmills, turn the on/off switch to the off position then back to the on position. On self powered units, disconnect the power source connected to the P80 console and then reconnect the power source.
2. Wait 15 seconds. It is critical that the timing be no less than 15 seconds and no greater than 45 seconds for the procedure to be successful.
3. **Repeat steps 1 and 2 for 6 additional power Off and On cycles.**
4. On the last or 7<sup>th</sup> cycle leave the power connected or the power switch turned to the On position allowing the P80 console to boot up completely.
5. If the P80 console boot up to the Welcome screen was successful, go to step 6. If the P80 console still will not boot to the Welcome screen contact PRECOR customer support.
6. Reprogram the P80 console with the most current software package available. See Procedure 3.5, P80 Updating Software, for instructions on how to reprogram the P80 console.

## Troubleshooting 3.22- P80 – Poor Quality Video – Single Unit Only

### Description

Television signal is present, but picture quality is consistently or inconsistently poor across all available channels.

### Possible Causes

1. Loose or damaged coaxial cable
2. Poor television signal to the machine
3. Incorrect region setting in channel settings

### Possible Remedies

1. Check for good video signal to the tuner.
  - a. Inspect jumper cable connecting fitness equipment to the video drop. If it is visibly damaged or disconnected, replace or reconnect. If it passes visual inspection, swap with a known good jumper cable. If a TV channel now appears, the cable is the cause. Replace the jumper cable. If the channel does not appear, perform the same check on the F connectors.
  - b. Inspect the cable that runs from the patch panel at the bottom of the machine to the console. If this is disconnected or damaged, reconnect or replace. If the cable passes visual inspection, use a known good cable to bypass this cable. If the TV channel appears, replace the coax cable running through the machine.
  - c. Connect the machine to a known good A/V drop. If the TV channel now appears on the console, verify the drop is good. If not, have the customer contact their A/V service technician to repair the drop.
  - d. Verify signal strength with signal meter.
2. As above, verify condition and connections of coax cables as well as verify quality of signal to that drop. Verify signal strength with signal meter.
3. Enter the Settings Menu. Select System Settings, then TV Settings. Verify that unit is set for United States. See Procedure 3.9. TV Settings.



## Troubleshooting 3.23 - P80 - Poor Quality Video - All Units

### Description

Television signal is present, but picture quality is consistently or inconsistently poor across all available channels.

### Possible Causes

1. Loose or damaged coaxial cable at or near head end.
2. Poor television signal from head end.
3. Poor television signal to club.
4. All machines were configured using incorrect region setting.

### Possible Remedies

1. Verify condition and connections of video distribution network. Begin as close to head end as possible and check for visible damage to coaxial cables or connectors. Verify all connections are tight.
2. Check signal quality and strength as close to head end as possible. If poor from the head end have customer contact their A/V service company to ensure signal from head end is within acceptable parameters.
3. Troubleshoot as above. Signal provider (e.g. Cable Company, Satellite Company, etc.) will need to address this issue.
4. Enter the Settings Menu. Select System Settings, then TV Settings. Verify that unit is set for United States.. See Procedure 3.9. TV Settings.

## Troubleshooting 3.24 - P80 – Poor Quality Video – One Channel(s) or Limited Channels

### Description

One or a limited number channels on a unit has poor reception or no reception.

### Possible Causes

1. Loose or damaged coaxial cable.
2. Poor television signal to the machine.
3. Incorrect channel scan lineup.

### Possible Remedies

1. Check for good video signal to the tuner.
  - a. Inspect jumper cable connecting fitness equipment to the video drop. If it is visibly damaged or disconnected, replace or reconnect. If it passes visual inspection, swap with a known good jumper cable. If the TV channel now appears, the cable is the cause. Replace the jumper cable. If the channel does not appear, perform the same check on the F connectors.
  - b. Inspect the cable that runs from the patch panel at the bottom of the machine to the console. If this is disconnected or damaged, reconnect or replace. If the cable passes visual inspection, use a known good cable to bypass this cable. If the TV channel appears, replace the coax cable running through the machine.
  - c. Connect the machine to a known good A/V drop. If the TV channel now appears on the console, verify the drop is good. If not, have the customer contact their A/V service technician to repair the drop.
  - d. Verify signal strength with signal meter.
2. As above, verify condition and connections of coax cables as well as verify quality of signal to that drop. Verify signal strength using a signal meter.
3. Rescan channels on that unit. This is less likely to be the problem if the channel is coming in poorly since if the console is looking at the wrong channel number entirely, this should manifest as a black TV screen rather than poor video quality.

## Troubleshooting 3.25 - P80 - Green Screen

### Description

Entire touch screen is displaying a green color. No response to any inputs, machine is completely unusable.

### Possible Causes

1. Operation System, kernel crash. Operating System is completely hung up, no error logging is able to occur.

### Possible Remedies

1. Reboot machine.

## Troubleshooting 3.26 - P80 - Stuttering Channels

### Description

TV channels stutters and skips regularly every second or so. Video and audio skip together. If the skipping channel is left on, the TV may go black for a short time and the mediaapp will be reset by the system.

### Possible Causes

1. Tuner tuned improperly to the channel

### Possible Remedies

Change the channel to a different channel. The skipping will now be gone and the user can change back to the original channel.

## Troubleshooting 3.27 - P80 – Touch Screen Unresponsive

### Description

Touch screen does not respond to any touches. Screen may show a static or a moving image, but is not completely black.

### Possible Causes

1. Console was improperly calibrated or has fallen out of calibration
2. Console has locked up.
3. Touch Screen is defective

### Possible Remedies

1. Use Single Secret Handshake to enter screen calibration. See Single Secret Handshake Procedure below. Press each 'X' in sequence to recalibrate the screen. See Procedure 3.6, Systems Test. Ensure the person recalibrating is standing on the machine and is not holding on to the console or any other part of the machine while doing so.
2. Reboot the machine
3. If touch screen has failed entirely, console will need to be replaced. This is not a replaceable part.

### Single Secret Handshake Procedure

Press the Pause key and continue holding it down while you press in sequential order an U configuration on the Volume and Channel key pad (① Channel Up, ② Channel Down, ③ Volume Down, ④ Volume Up). See Diagram 3.27.1. Release the Pause key when done pressing the arrows. **Note: The keypad U configuration sequence should be not faster than 1 second between each key stroke.** Any speed faster than 1 second may result in an unsuccessful access to the sign-in screen.

Diagram 3.27.1



Volume &  
Channel Key Pad

Pause Button

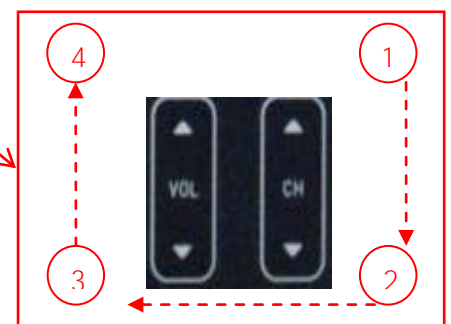

## Troubleshooting 3.28- P80 – Touch Screen Slow Response

### Description

Touch screen responds appropriately to touches, but does so slowly. The screen may or may not play the animations associated with the touches when carrying out the appropriate action.

### Possible Causes

1. The console is running low on memory.

### Possible Remedies

1. Reboot the console. This will clear the memory and restore the unit to normal operation.

## Troubleshooting 3.29 - P80 – Touch Screen Responds Incorrectly to Touch

### Description

Touch screen reads touches, but it is not registering them where the user is touching the screen.

### Possible Causes

1. The touch screen was improperly calibrated or has fallen out of calibration.

### Possible Remedies

1. Use Single Secret Handshake to enter screen calibration. See Single Secret Handshake Procedure below. Press each 'X' in sequence to recalibrate the screen. See Procedure 3.6, Systems Test. Ensure the person recalibrating is standing on the machine and is not holding on to the console or any other part of the machine while doing so.

### Single Secret Handshake Procedure

Press the Pause key and continue holding it down while you press in sequential order an U configuration on the Volume and Channel key pad (① Channel Up, ② Channel Down, ③ Volume Down, ④ Volume Up). See Diagram 3.27.1. Release the Pause key when done pressing the arrows. **Note: The keypad U configuration sequence should be not faster than 1 second between each key stroke.** Any speed faster than 1 second may result in an unsuccessful access to the sign-in screen.

Diagram 3.27.1



Volume &  
Channel Key Pad

Pause Button

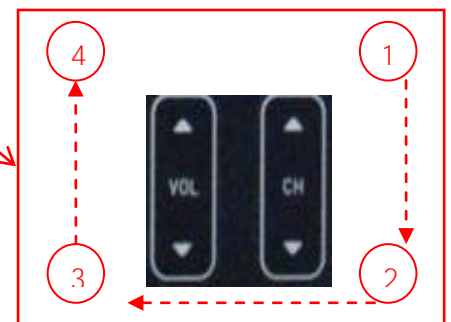

## Troubleshooting 3.30 - P80 - Poor Audio Quality - All Channels, One/Limited Units

### Description

While video signal is good to one or a few machines, the sound is of poor quality.

### Possible Causes

1. Bad or damaged headphone jack
2. Bad or damaged headphone jack cable
3. Poor television signal to the machine

### Possible Remedies

1. Remove and inspect headphone jack for damage. If jack passes visual inspection, swap headphone jack with known good.
2. Inspect cables from console to headphone jack. Verify that they are not damaged. If they are, these are not field-replaceable. Console will need to be swapped.
3. Check for good video signal to the tuner. Generally, however, if the issue is a cabling issue, the video will be bad along with the sound. However, if there is an issue with how the amplifier in the head end is configured, this could result in good video, but poor sound, though this is likely to be an issue across all units rather than a subset of the entire facility.



## Troubleshooting 3.31 - P80 – Poor Audio Quality – All Channels, Multiple Units

### Description

While video signal is good to one or a few machines, the sound is of poor quality.

### Possible Causes

1. Bad or damaged headphone jack
2. Bad or damaged headphone jack cable
3. Poor television signal from the head end

### Possible Remedies

1. Remove and inspect headphone jacks for damage. If jack passes visual inspection, swap headphone jack with known good.
2. Inspect cables from console to headphone jack. Verify that they are not damaged. If they are, these are not field-replaceable. Console will need to be swapped.
3. Check for good video signal from the head end. Generally, however, if the issue is a cabling issue, the video will be bad along with the sound. However, if there is an issue with how the amplifier in the head end is configured, this could result in good video, but poor sound, though this is likely to be an issue across all units rather than a subset of the entire facility.

## Troubleshooting 3.32 - P80 - Machine Controls Unresponsive

### Description

Machine controls do not respond to input. User is unable to change workout parameters.

### Possible Causes

1. Cable from machine controls to upper board is damaged or not inserted properly.
2. Machine controls have failed

### Possible Remedies

1. Check yellow/black cable in console for damage. Ensure the cable is inserted fully onto the pins. If not inserted properly, insert. If cable is damaged, console must be replaced; this is not a replaceable part.
2. If machine controls have failed, the entire console will need to be replaced. This is not a replaceable part.

## Troubleshooting 3.33 - P80 - Machine Controls Incorrect Response

### Description

Machine controls do not respond properly to input – speed up makes speed go down, incline up makes incline go down, etc.

### Possible Causes

1. Bounce-back If the user is flipping the machine controls with a lot of force, the control could rebound with enough force to cause it to bounce in the other direction, causing the machine to think the user is actually pressing it in that direction.
2. Cable from machine controls to upper board is damaged or not inserted properly.
3. Machine controls have failed

### Possible Remedies

1. Verify the user is not using excessive force on the controls. Test to make sure they are operating properly when appropriate force is used. Educate customer on proper use of equipment.
2. Test controls in Systems Tests. See Procedure 3.6, Systems Test. Check yellow/black cable in console for damage. Ensure the cable is inserted fully onto the pins. If not inserted properly, insert. If cable is damaged, console must be replaced; this is not a replaceable part.

## Troubleshooting 3.34- P80 – Message Out of Service Displayed

### Description

Console is displaying a message that says Temporarily Out of Service. Please use another machine.

### Possible Causes

1. Software has encountered an error causing the console to enter Out of Service mode
2. The Auto Stop sensor on a treadmill is missing, improperly installed, or malfunctioning (Treadmill Only).

### Possible Remedies

1. Reboot the console. Most issues causing Out of Service errors will be cleared from a reboot.
2. Treadmill Only. Inspect the Auto Stop sensor and ensure it is installed properly. Inspect Auto Stop cable to ensure it is inserted properly and undamaged. Repair or replace if needed. OOS error will clear as soon as the sensor is detected. Do not disable the Auto Stop sensor in the software. For more trouble shooting information on the Auto Stop feature see Troubleshooting- 9.5 – TRM\_ Trouble Shooting the Auto Stop Feature.

## Troubleshooting 3.35 - P80 – Message Please Reset the Treadmill Displayed

-

### Description

On a treadmill, the screen displays the message, Please Reset the Treadmill along with a graphic of the stop switch.

### Possible Causes

1. The Stop Switch lanyard has been pulled and the reset latch has been disengaged. The yellow button will be raised on the dash.
2. The stop switch reset latch has been engaged, but not fully so.
3. The cable connecting the stop switch to the console is disconnected, loose, or damaged.
4. The stop switch is malfunctioning

### Possible Remedies

1. Press down firmly the yellow button on the dash. The tread will reset itself shortly.
2. Pull the lanyard to disengage the reset latch. Press down firmly on the yellow button on the dash to reset the treadmill.
3. Inspect the connections leading from the stop switch to the console. Ensure that the cables are secure and undamaged.
4. Replace the stop switch assembly.

## Troubleshooting 3.36 - P80 – Unit reboots of its own volition

### Description

Console fully reboots without any outside input, either during the boot process or while in operation.

### Possible Causes

1. Power connections outside fitness equipment are loose or bad
2. Power connections inside fitness equipment are loose or bad
3. Faulty power supply
4. Facility power is not configured correctly.
5. Faulty console

### Possible Remedies

1. Inspect power cord from wall plate to power supply (if non-Treadmill) or patch panel (if Treadmill). Verify all connections are tight and that there is no damage. Swap with known good cable, if appropriate. Inspect connections from power supply to patch panel (if non-Treadmill). Reconnect or replace all cables as needed.
2. Open the machine and inspect the power cord running from patch panel to console (if non-Treadmill) or from patch panel to power supply (if Treadmill). Swap with known good to test, if needed. On Treads, also check from power supply to console. Again, swap with known good to test.
3. Inspect power supply for damage. Swap with known good power supply to test. Replace, if needed.
4. Ensure that facility has configured their power correctly. About 8 non treadmill units can be connected through one dedicated circuit. Each treadmill must be on a dedicated, branch circuit. Neutrals and Hot Leads must not be shared among treadmills. If the power supplied to the machines is not up to specification, the customer will need to contact an electrician to make the needed repairs.
5. If the power, power supply, and power cabling are all good and securely connected, the console will need to be replaced.

## Section Four – Future Content

## Section Five - P30 Console - AMT





## Procedure 5.1 - P30 - Accessing the Diagnostic Software

The P30 Console diagnostic software consists of the following modes:

- Display Test
- Keyboard Test
- Heart Rate Test
- Brake Test
- RPM Test
- Battery Test
- Stride Position Test

### Procedure:

1. The AMT 885 and 835 uses the standard access codes to provide access to the various software features. Use the PAUSE key and the numeric keypad to enter the access code. The standard access codes use all sequential key presses. The allowable delay between key presses is short. . If too much time is taken between key presses or the wrong key is pressed the access procedure will be aborted. If the access is aborted, it will be necessary to start over from the beginning.
2. Diagram 5.1 .1 - P30 Console - AMT



## 3. See Diagnostic Software Menu Table.

Diagnostic Software Menu - Table

Test Type	Action	Descriptions
Display Test	Press keys PAUSE,5,1,7,6,5,7,6,1, sequentially.	Hardware Validation will scroll across the display followed by DISPLAY TEST.
	Press OK key	The upper most group of LED's will illuminate on the display. Check the display to ensure that all LED segments are illuminated.
	Press the OK key four more times	To display the remaining LED groups. Check each display group to ensure that all LED segments are illuminated.
	Press the CLEAR key to return to Hardware Validation	
Keyboard Test	Press the ▼ key	KEYBOARD TEST will scroll across the display
	Press the OK key	A representation of all of the keys on the console will be displayed. Pressing a key on the console will cause the illuminated representation of that key to turn off. Press all of the keys on the console to ensure that all of the keys are functioning.
	Press and hold the CLEAR key for <u>5 seconds</u> to return to Hardware Validation	
Heart Rate Test	Press the ▼ key	HEART RATE will be displayed.
	Press the OK key	Grasp both of the heart rate grips on the handlebar, after a couple of seconds the heart rate will be displayed in the heart rate and smart rate displays.  Use chest strap transmitter or a test transmitter to test the wireless heart rate function, after a couple of seconds the heart rate will be displayed in the heart rate and smart rate displays.
	Press the CLEAR key to return to Hardware Validation	
Brake Test	Press the ▼ key	BRAKE will be displayed.
	Press the OK key	The console will display the power bits (PWRB). Changing the resistance ▲,▼ keys will change the power bit settings.
	Press the CLEAR key to return to Hardware Validation	
RPM Test	Press the ▼ key	RPM will be displayed.
	Press the OK key	The console will display the Pulse. The pulse is showing a count of zero crossings from the generator. RPM shows a software averaged version of pulse. Use ▲,▼ keys to view the following RPM readings. <ul style="list-style-type: none"> <li>• PULSE</li> <li>• MIN</li> <li>• MAX</li> </ul>
	Press the CLEAR key to return to Hardware Validation	
Battery Test	Press the ▼ key	BATTERY will scroll across the display.
	Press the OK key	The console will display the battery test. Battery test will display battery voltage.
	Press the CLEAR key to return to Hardware Validation	

	Press the CLEAR key to return to Hardware Validation	
Stride Position Test	Press the ▼ key	STRIDE POSITION TEST will scroll across the display.
	Press the OK key	The low, high and actual stride positions will be displayed. The low display shows the lowest position reading achieved during the test. The high display shows the highest position reading achieved during the test. The actual display changes with the current stride position. Stride on the AMT to the maximum horizontal movement in both directions. At maximum stride length the low stride display should read 0 and the high stride display should read 40.
	Press the CLEAR key to return to Hardware Validation	
	Press the PAUSE/RESET key to exit the Hardware Validation tests.	

## Procedure 5.2 - P30 - Displaying Information

The information display will access the following data;

- Odometer
- Hour Meter
- U-Boot Software
- U-Base Software
- Lower Software
- Metrics Board Software
- Stride Dial Software
- Serial Number
- Usage log
- Error Log

### Procedure

1. See Displaying Information Menu - Table

#### Displaying Information Menu -Table

Displayed Information	Action	Description
Diagnostics Information	<p>With the <b>PRECOR</b> banner scrolling, press the keys <b>PAUSE,6,5</b>, sequentially.</p> <p>Use the <b>▲,▼</b> keys to move to the desired display shown in the list above.</p>	DIAGS _ INFORMATION will scroll across the display. Followed by ODOMETER.
Odometer	Press the OK key.	The odometer will display HORIZONTAL distance in miles or KM depending on Club parameter settings and VERTICAL distance in steps.  Note: The odometer data is stored in non-volatile memory on the upper PCA. If the upper PCA is replaced the odometer data will be lost.
	Press the CLEAR key to exit the odometer display.	
Hour Meter	Use the <b>▲,▼</b> keys to move to move to HOUR METER.	
	Press the OK key.	The operating time of the unit will be displayed as 12345 HOURS. The operating time is defined as total amount of time that the unit has operated in program. The hour meter is also used to provide the time stamp for the error code log.
	Press the CLEAR key to exit the HOUR METER display.	
U-Boot SW	Use the <b>▲,▼</b> keys to move to move to U-BOOT SW.	
	Press the OK key.	The software part number will be displayed as XXXXX-XXX.

	Press the CLEAR key to exit the U-BOOT SW display.	
U-Base SW	Use the ▲, ▼ keys to move to move to HOUR METER.	
	Press the OK key.	The software part number will be displayed as XXXXX-XXX.
	Press the CLEAR key to exit the U-BASE SW display.	
Lower SW	Use the ▲, ▼ keys to move to move to LOWER SW.	
	Press the OK key.	The software part number will be displayed as XXXXX-XXX.
	Press the CLEAR key to exit the LOWER SW display.	
Metrics Board SW	Use the ▲, ▼ keys to move to move to METRICS BOARD SW.	
	Press the OK key.	The software part number will be displayed as XXXXX-XXX.
	Press the CLEAR key to exit the Metrics BOARD SW display.	
Stride Dial SW	Use the ▲, ▼ keys to move to move to STRIDE DIAL SW.	
	Press the OK key.	The software part number will be displayed as XXXXX-XXX.
	Press the CLEAR key to exit the STRIDE DIAL SW display.	
Serial Number	Use the ▲, ▼ keys to move to move to SER. NUMBER.	
	Press the OK key.	The serial number will be displayed. The serial number may be incorrect or not displayed if the upper PCA has been replaced.
	Press the CLEAR key to exit the SER. NUMBER display.	
Usage log	Use the ▲, ▼ keys to move to move to USAGELOG.	
	Press the OK key.	A message will scroll describing the program, the number of times and the number of minutes the program was used.
	Use the ▲, ▼ keys to move through the list of programs	
	Press the CLEAR key to exit the USAGELOG display.	
Error Log	Use the ▲, ▼ keys to move to move to ERROR LOG.	
	Press the OK key.	The quantity of errors in the log will be displayed.
	Press the OK key.	The most recent error will be displayed first.
	Use the ▲, ▼ keys to move through the list of errors.	The error messages will list the error name, the odometer reading when the error occurred and the hour meter when the error occurred.
	If you wish to clear the error log, press and hold the QUICK START key.	The message HOLD TO CLEAR ERRORS will be displayed. The error log will be cleared when the message NO ERRORS is displayed.  Please <b>note</b> that the ERROR LOG may also be accessed at any time by pressing and holding the CLEAR key for four seconds. If the error log does not contain any errors, the message STUCK KEY will be displayed.
	Press the CLEAR key to exit the ERROR LOG display.	
	Press the PAUSE key to exit the DIAGS-INFORMATION DISPLAY.	

## Procedure 5.3 – P30 – Setting Club Parameters

This procedure allows you to change the following club settings:

- Select Language
- Select Units
- Set Max Workout Time
- Set Max Pause Time
- Set Cool Down Time

### Procedure

1. See Setting Club Settings Menu - Table

#### Club Settings Menu - Table

Setting	Action	Description
Club Settings	With the banner scrolling, press keys PAUSE,5,6,5,1,5,6,5, sequentially.	DIAGS-SET CLUB PARAMETERS will scroll across the display followed by select LANGUAGE.
Set Language	Press the OK key.	
	Use the ▲,▼ keys to toggle between the available languages.	A list of available languages will be displayed, including <ul style="list-style-type: none"> <li>• ENGLISH</li> <li>• DEUTSCH</li> <li>• ESPANOL</li> <li>• FRANCAIS</li> <li>• NEDERLANDS</li> <li>• PORTUGUES</li> <li>• RUCCKIJI</li> <li>• ITALIANO</li> </ul> Note: When the default language is changed to anything other than English, the submenus will remain in English.
	Press the OK key to select desired language and exit to Club Settings.	UNITS will be displayed.
Set Units	Press the OK key.	
	Use the ▲,▼ keys to toggle between U.S and METRIC.	U.S (miles per hour) and METRIC (kilometers per hour) will be displayed.
	Press the OK key to select desired unit exit to Club Settings.	SET MAX WORKOUT TIME will be displayed.
Set Max Workout Time	Press the OK key.	
	Use the ▲,▼ keys to select the maximum time a user can remain in a program.	As the ▲,▼ keys are pressed, the displayed value increments or decrements between 1 and 240 minutes, and NO LIMIT. If an arrow key is held down then the value changes slowly at first and then at an increasing rate.
	Press the OK key to save selection and exit to Club Settings.	SET MAX PAUSE TIME will be displayed.

Set Max Pause Time	Press the OK key.	
	Use the ▲, ▼ keys to select the maximum time the unit will remain in paused before resetting.	As the ▲, ▼ keys are pressed, the displayed value increments or decrements between 1 and 120 seconds. If an arrow key is held down then the value changes slowly at first and then at an increasing rate.
	<b>Press the OK key to save selection and exit to Club Settings.</b>	SET COOL DOWN TIME will be displayed.
Set Cool Down Time	Press the OK key.	
	Use the ▲, ▼ keys to select the cool down time.	As the ▲, ▼ keys are pressed, the displayed value increments or decrements between 0 and 5 minutes.
	Press the OK key to save selection and exit to Club Settings.	SET METRIC DEFAULTS will be displayed.
	Press the OK key.	
Set Metric Defaults	Use the ▲, ▼ keys to select the default settings that will be displayed during a workout.	A list of available default settings will be displayed, including: <ul style="list-style-type: none"> <li>• OFF</li> <li>• % COMPLETE</li> <li>• TIME IN ZONE</li> <li>• SEGMENT TIME REMAINING</li> <li>• AVERAGE SPEED</li> <li>• CALS/MIN</li> <li>• CALS/HR</li> <li>• WATTS</li> <li>• METS</li> <li>• TARGET HR</li> <li>• AVE HEART RATE</li> <li>• SHOW ALL</li> </ul>
	Press the OK key to save selection and exit to Club Settings.	CROSSRAMP AUTO-LEVEL will be displayed.
Set Crossramp Auto-Level	Press the OK key.	
	Use the ▲, ▼ keys to select height the crossramp will return to when after a workout.	As the ▲, ▼ keys are pressed, the displayed value increments or decrements between XRAMPS 1 and 120 seconds. If an arrow key is held down then the value changes slowly at first and then at an increasing rate.
	Press the OK key to save selection and exit to Club Settings.	HIDDEN PROGRAMS will be displayed.
Set Hidden Programs	Press the OK key.	
	Use the ▲, ▼ keys to select the either Show Programs or Hide Programs.	A list of available default settings will be displayed, including: <ul style="list-style-type: none"> <li>• SHOW PROGRAMS</li> <li>• HIDE PROGRAMS</li> </ul>
	Press the OK key to save selection and exit to Club Settings.	SET CUSTOM PROGRAMS will be displayed.

Set Custom Programs	Press the OK key.	
	Pressing the ▲, ▼ keys changes the active column. Pressing the corresponding ▲, ▼ resistance keys changes the resistance value for that column.	When this function is initiated, the currently stored custom program (#1 or #2) is displayed in the matrix. The first column is active; all the LEDs in that column blink. The resistance value for that column is displayed in the message bar.
	Press the OK key to save program and exit to Club Settings.	
	Press the PAUSE key exit Club Settings.	



## Procedure 5.4 - P30 - Documenting Software Problems

When a problem is found with the software in the upper or lower PCA, record the information listed below.

When a problem occurs, record the following information:

- Model and serial number
- Software version number
- Program number running when the problem occurred

A description of:

- What happened or failed to happen.
- The action taken by the user just before the problem occurred.
- Problem-related information (such as how far into the program the problem occurred, the work level being used when the problem occurred, error code displayed, etc.).
- The frequency of occurrence.

## Procedure 5.5 – P30 – Replacing Upper PCA

1. Set the treadmill circuit breaker in the off position and unplug the treadmill's line cord from the AC outlet.  
(TRM only)
2. The PCA's in the console are static sensitive. They can be damaged if proper static prevention equipment is not used. Attach an anti-static wrist strap to your arm, and then connect the ground lead of the wrist strap to the treadmill's frame ground.
3. Remove the two screws that fasten the dash transition cover and remove the cover. See Diagram 5.5.1

Diagram 5.5.1 – Dash Transition Cover – (TRM only)



4. Remove the four screws that fasten the console to the dash mounting plate. See Diagram 5.5.2.
5. **Diagram 5.5.2 – Dash Mounting Plate**

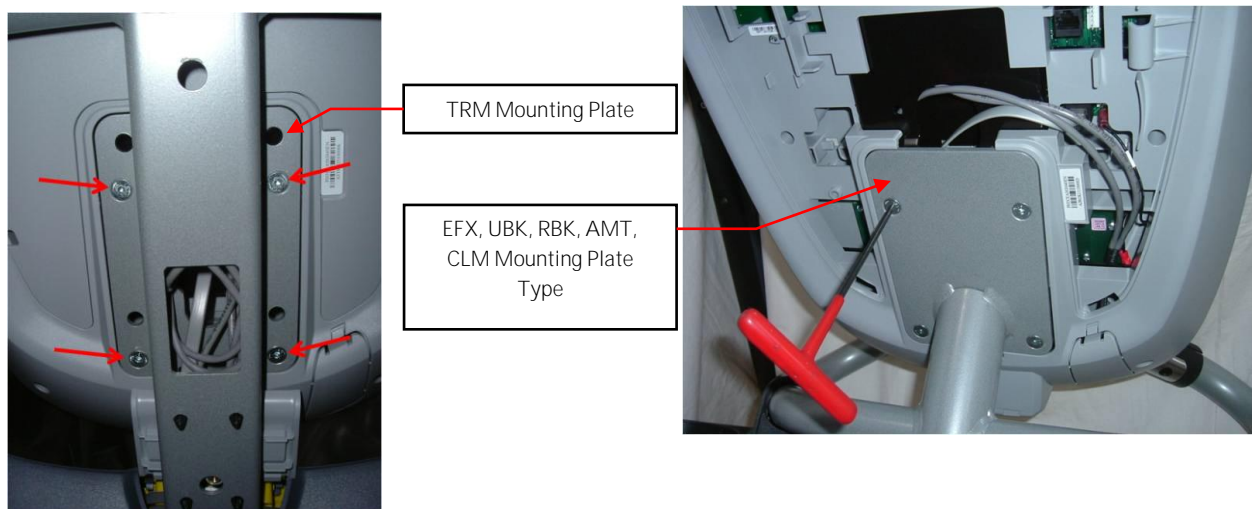

6. Remove the two screws that fasten the access panel to the console. See Diagram 5.5.3

Diagram 5.5.3 – Console Access Panel



7. Remove the back access Panel:
  - a. Treadmills: Lift the console off the maintenance hook and then position the console so that the back panel is accessible and remove the back cover.
  - b. AMT's, EFX's, CLM's, UBK's, and RBK's: Tilt the console forward on the maintenance access hook on the dash weldment and remove the back. See Diagram 5.5.4.

Diagram 5.5.4 – Maintenance Access Hook



8. Remove the Heart Rate PCA. See Procedure 5.7, Removing Heart Rate PCA.
9. Disconnect the Heart Rate Cable from the Heart Rate PCA.
10. Disconnect the Data cable, Auto Stop cable (Treadmill only), Stop Key cable(Treadmill only), Ground wire and the CSAFE cable (if in use) from the Upper PCA. See Diagram 5.5.5. Remove the console from the maintenance access hook and place it on a flat work surface.

Diagram 5.5.5 – P30 Cable Connectors

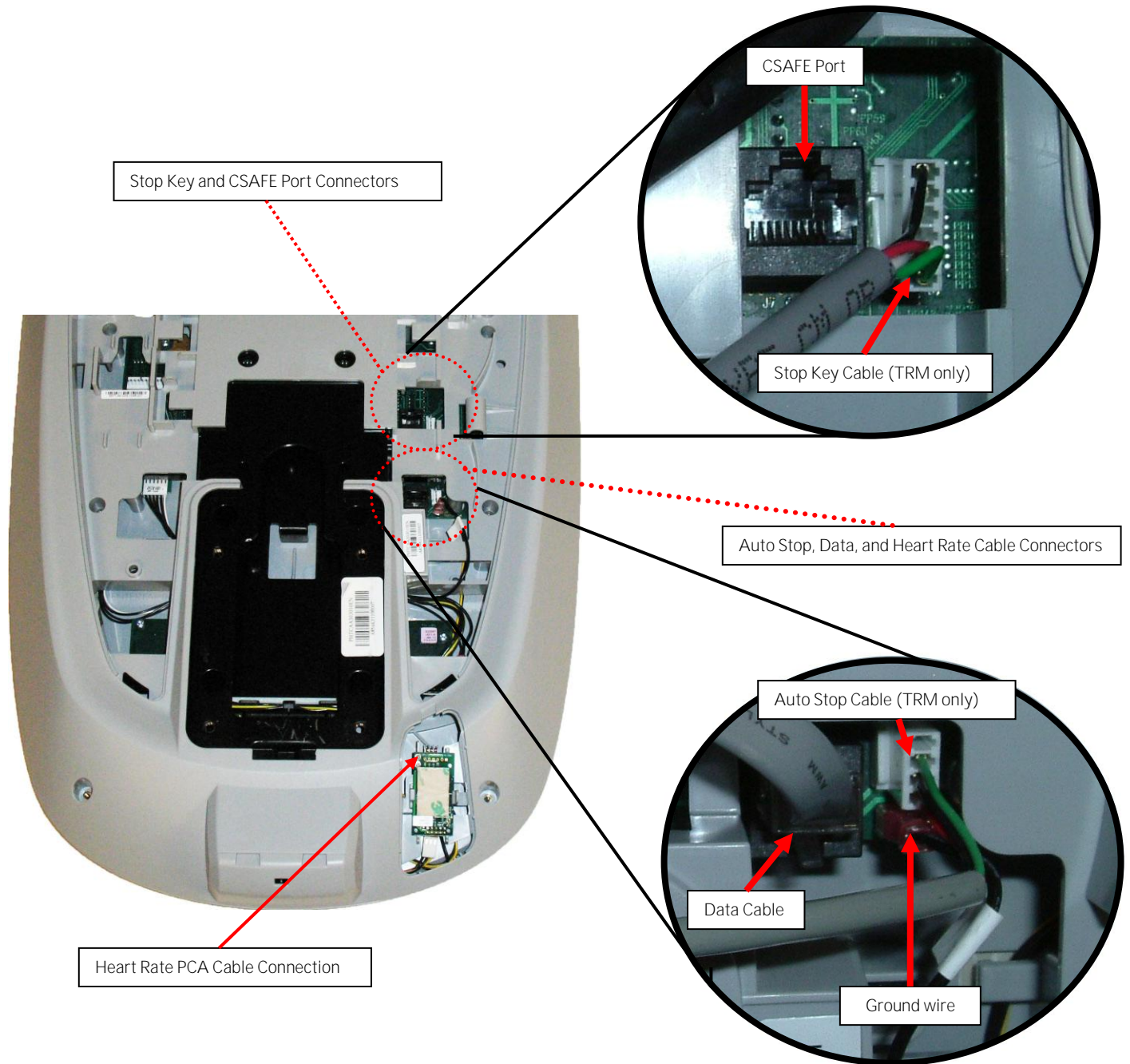

11. Remove the two screws that fasten the back cover to the option cap and remove the cover. See Diagram 5.5.6

Diagram 5.5.6 – Option Cap Back Cover



12. Remove the 6 screws that fasten the rear cover from the console and remove. See Diagram 5.5.7.

Diagram 5.5.7 – Rear Console Cover

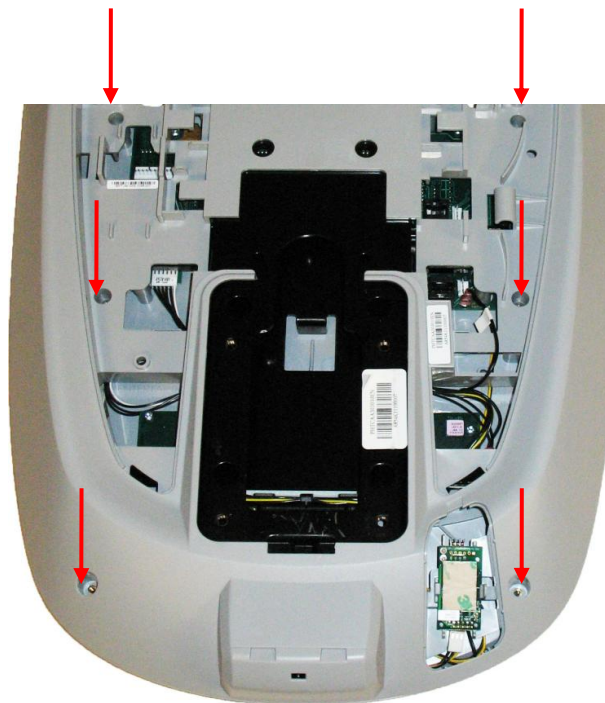

13. Disconnect the Metric cable (J5), Machine Controls cable (J4), Option Cap cable (J6, if applicable), Keypad Metric cable (J9) and HR cable (J10) from the Upper PCA board. See Diagram 5.5.8.
14. Remove the five screws that fasten the Upper PCA board to the console and remove the Upper PCA.

Diagram 5.5.8 – P30 Electronic Components

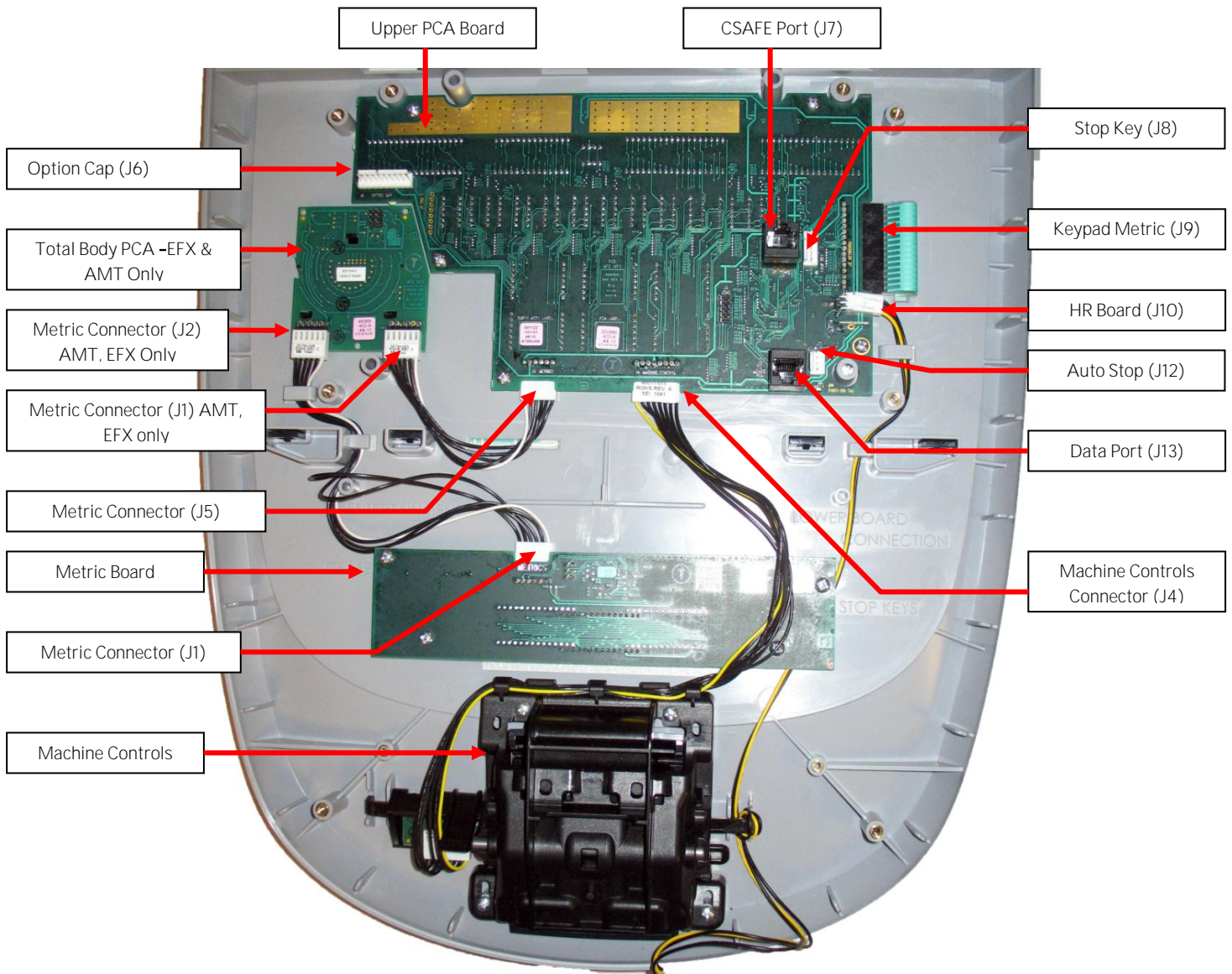

15. Install the replacement upper PCA into the console using the five screws removed in step 14. Torque to 10 inch pounds.

Note: Do not use an electric screw driver or over tighten the screws. Over tightening may damage the console. This type of damage is not covered under warranty.

16. The white wire in the Metrics cable and the yellow wire in the Machine Controls and HR cables indicate pin 1. Align the white wire in the Metrics cable and yellow wires in the Machine Controls and HR cables with the pin 1 markings on the upper PCA. See Diagram 5.5.9

Note: If pin 1 is not marked on the Upper PCA refer to Diagram 5.5.9.

Diagram 5.5.9 - P30 PCA - Pin 1 Reference

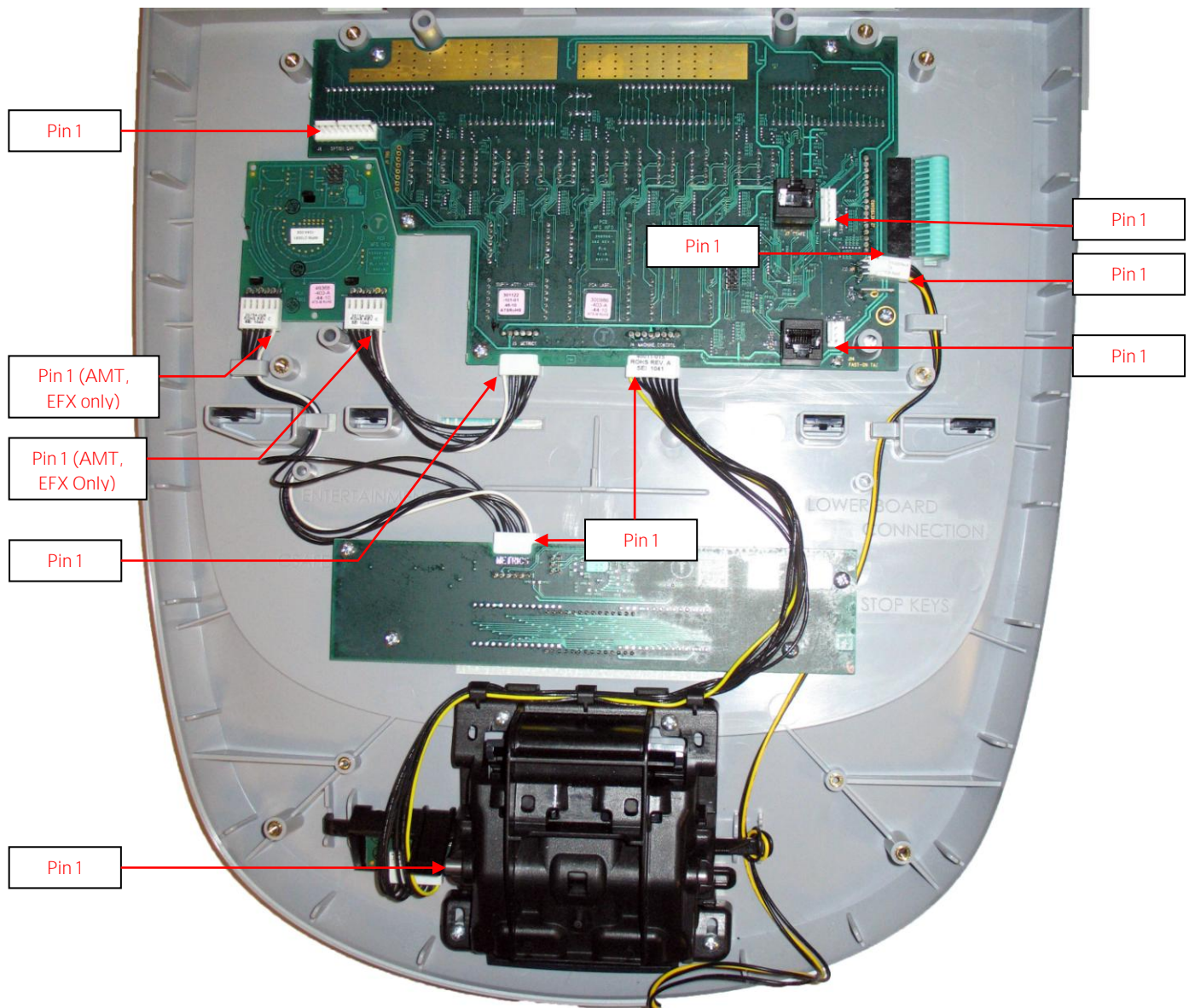

17. Reconnect the Metric cable (J5), Metric cable (J1), Metric cable (J2), Machine Controls cable (J4), Option Cap cable (J6, if applicable), Keypad Metric cable and HR cable (J10) from the Upper PCA board. See Diagram 5.5.8 cables to the Upper PCA.
18. Replace the P30 Rear Cover removed step 12 and secure the cover with the screws 6 screws. Torque to 10 inch pounds.

Note: Do not use an electric screw driver or over tighten the screws. Over tightening may damage the console. This type of damage is not covered under warranty.
19. Replace the P30 Option Cap back cover removed step 11 and secure the cover with the screws 2 screws. Torque to 10 inch pounds.

Note: Do not use an electric screw driver or over tighten the screws. Over tightening may damage the console. This type of damage is not covered under warranty.
20. Place the P30 console on the maintenance access hook.
21. Reconnect the Data cable, Auto Stop cable (Treadmill only), Stop Key cable (Treadmill only), Ground wire and the CSAFE cable (if in use) to the Upper PCA. See Diagram 5.5.5.
22. Reconnect the Heart Rate Cable to the Heart Rate PCA.
23. Replace the Heart Rate PCA. See Procedure 5.7, Removing Heart Rate PCA
24. Replace the access cover with the hardware removed in step 6.
25. Tilt the console back against the mounting plated. While tilting the console back feed the excess cable into weldment tube making sure that the cables will not become pinched.
26. Fasten the console to the dash mounting plate with the four screws removed in step 4. See Diagram 5.5.2.
27. Fasten the dash transition cover using the two screws removed in step 3. See Diagram 5.5.1
28. Check treadmill operation per Section Seven.



## Procedure 5.6 - P30 - Replacing Metric PCA

1. Set the treadmill circuit breaker in the off position and unplug the treadmill's line cord from the AC outlet. **(TRM only)**.
2. The PCA's in the console are static sensitive. They can be damaged if proper static prevention equipment is not used. Attach an anti-static wrist strap to your arm, and then connect the ground lead of the wrist strap to the treadmill's frame ground.
3. Remove the two screws that fasten the dash transition cover and remove the cover. **(TRM Only)** See Diagram 5.6.1

Diagram 5.6.1 - Dash Transition Cover - (TRM only)



4. Remove the four screws that fasten the console to the dash mounting plate. See Diagram 5.6.2.

Diagram 5.6.2 Dash Mounting Plate

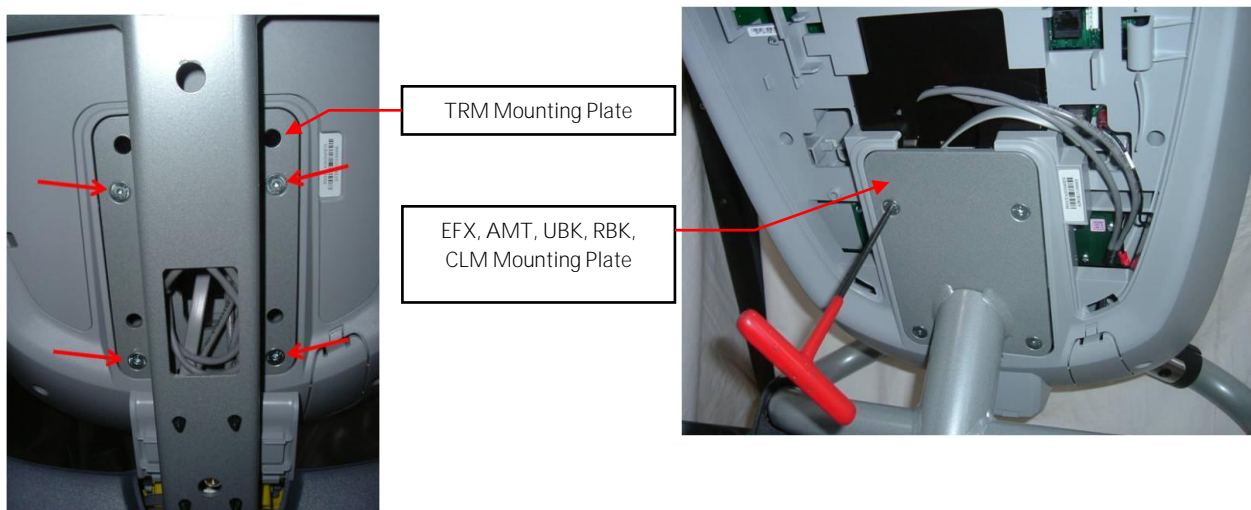

5. Remove the two screws that fasten the access panel to the console. See Diagram 5.6.3

**Diagram 5.6.3 – Console Access Panel**

6. Remove the back access panel:
  - a. Treadmills: Lift the console off the maintenance hook and then position the console so that the back panel is accessible and remove the back cover.
  - b. AMT's, EFX's, CLM's, UBK's, and RBK's: Tilt the console forward on the maintenance access hook on the dash weldment and remove the back. See Diagram 5.6.4.

**Diagram 5.6.4 – Maintenance Access Hook**

7. Remove the Heart Rate PCA. See Procedure 5.7, Removing Heart Rate PCA.
8. Disconnect the Heart Rate Cable from the Heart Rate PCA.

- 9. Disconnect the Data cable, Auto Stop cable (Treadmill only), Stop Key cable (Treadmill only), Heart Rate ground wire and the CSAFE cable (if in use) from the Upper PCA. See Diagram 5.6.5. Remove the console from the maintenance access hook and place it on a flat work surface.

Diagram 5.6.5 – P30 Cable Connectors

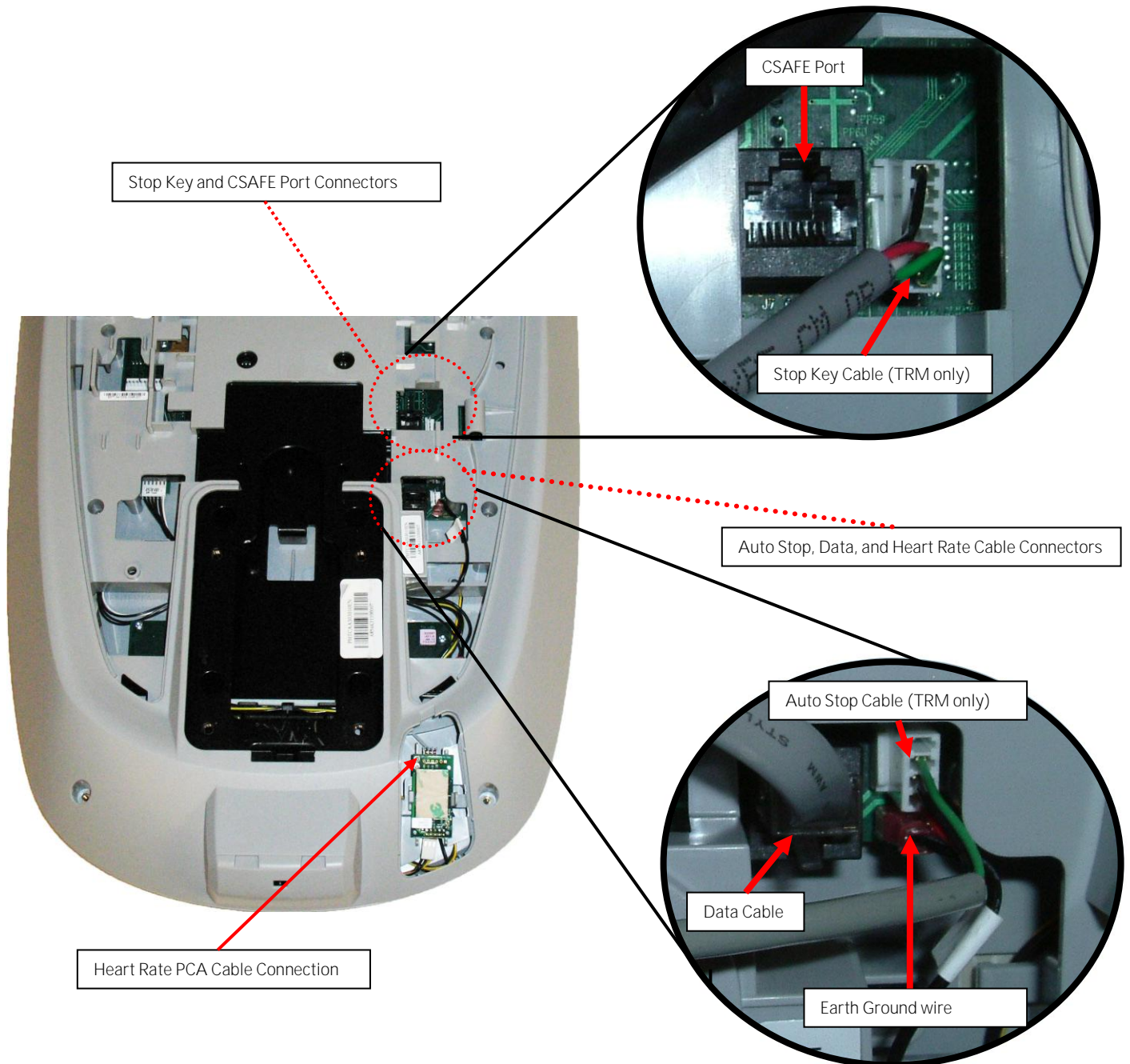

10. Remove the two screws that fasten the back cover to the option cap and remove the cover. See **Diagram 5.6.6**

Diagram 5.6.6 – Option Cap Back Cover



11. Remove the 6 screws that fasten the rear cover from the console and remove. See **Diagram 5.6.7**.

Diagram 5.6.7 – Rear Console Cover

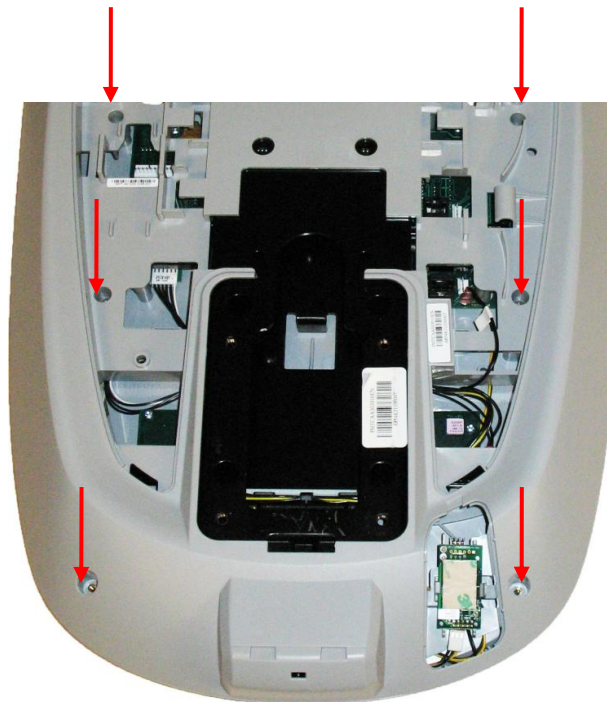

12. Disconnect the Metric cable (J1) from the Metric PCA board. See Diagram 5.6.8.
13. Remove the four screws that fasten the Metric PCA board to the console and remove the Metric PCA and the four spacers.

Diagram 5.6.8 - P30 Upper PCA &amp; Metric Board

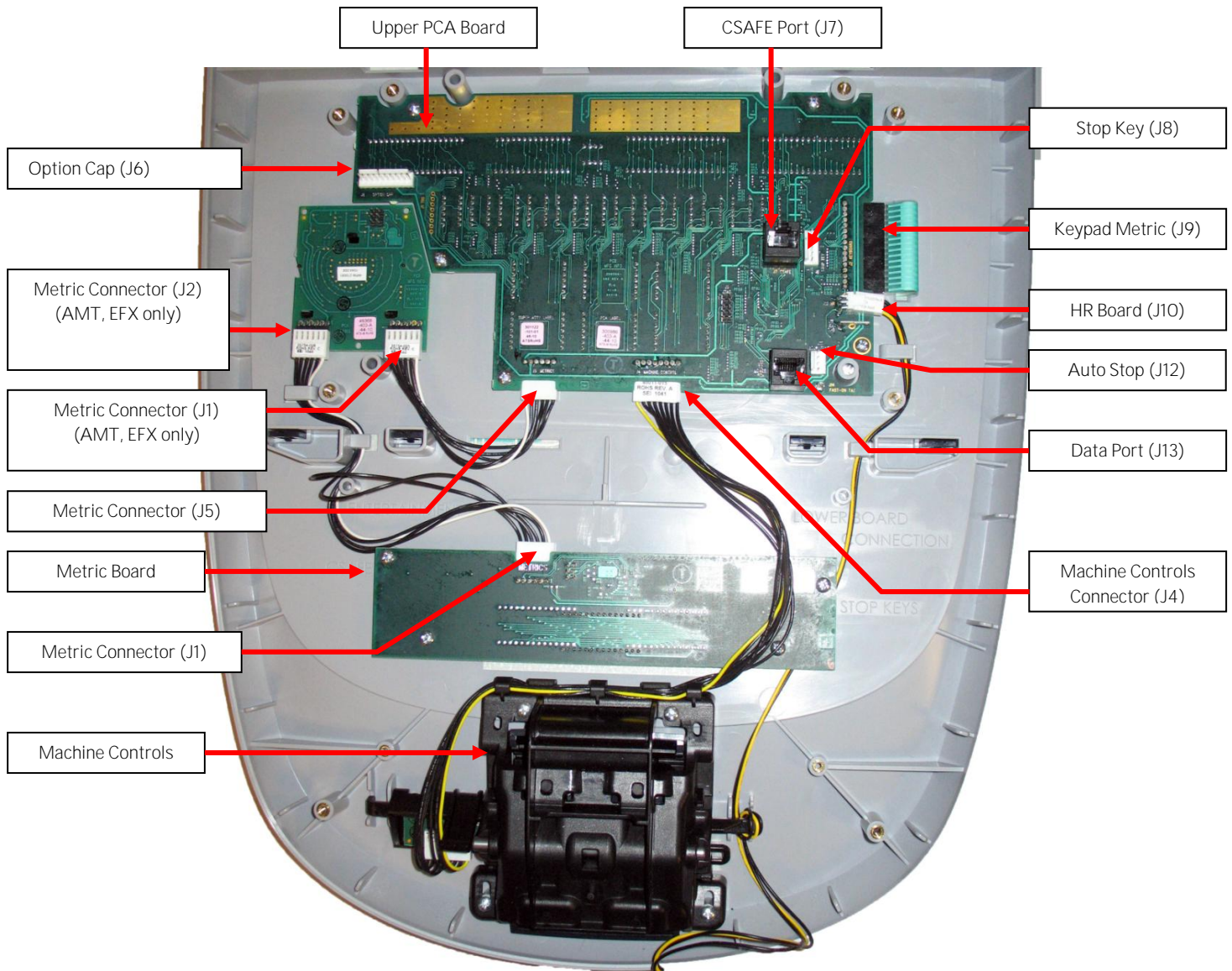

14. Replace the four spacers removed in step 13 onto the console mounting studs. The spacers must be used to insure the Metrics LED's are flush with the display window. If spacers are not used the Metrics LED's will apply excessive pressure on the Metrics board and may cause damage to the Metrics board.
15. Install the replacement Metric PCA into the console using the four screws removed in step 13.
16. The white wire in the Metrics cables indicate pin 1. Align the white wire in the Metrics cables with the pin 1 markings on the Metrics PCA. See Diagram 5.6.9

**Note:** If pin 1 is not marked on the Upper PCA refer to **Diagram 5.6.9**.

Diagram 5.6.9 - P30 PCA - Pin 1 Reference

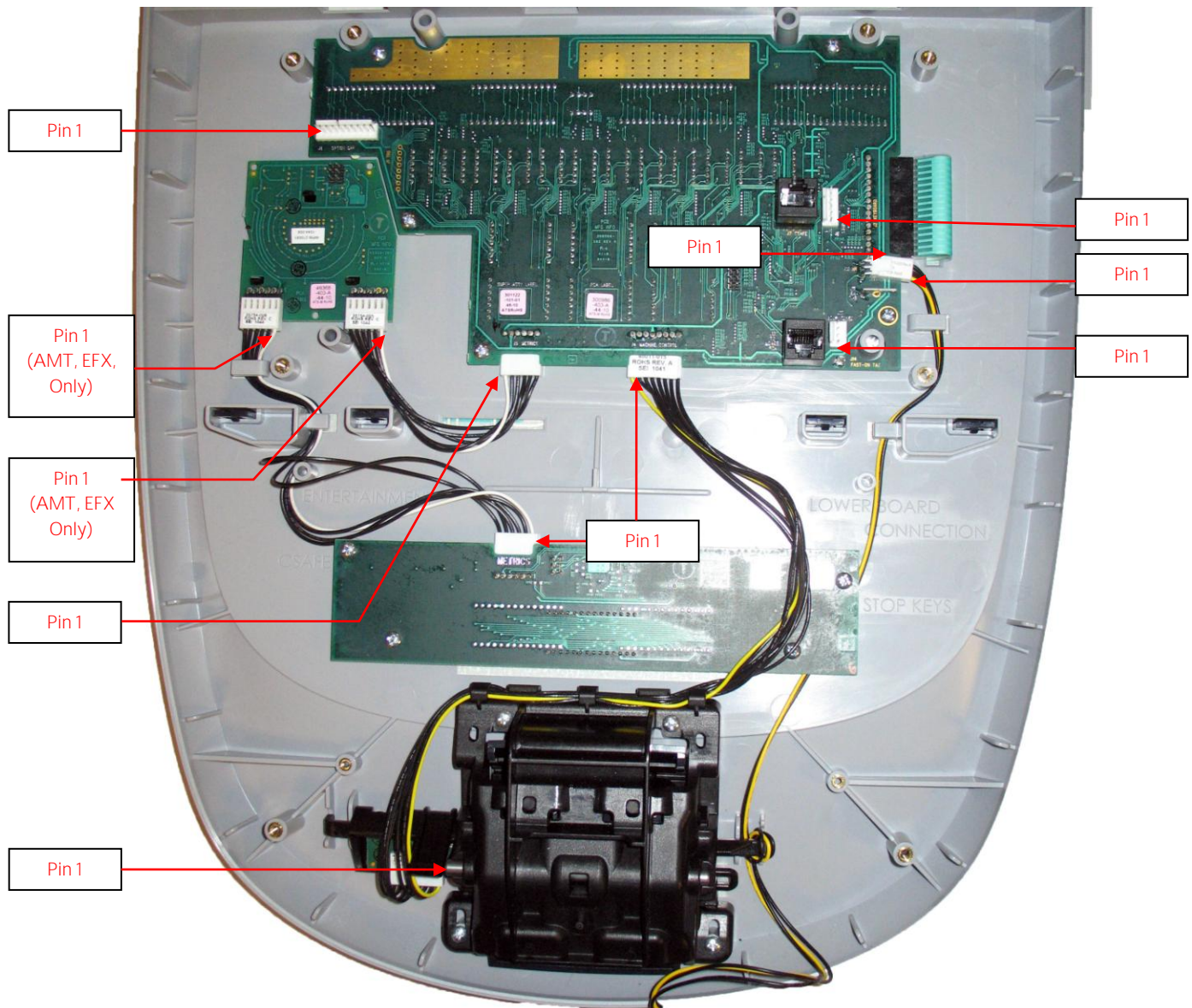

17. Connect the Metrics cable to the Metric PCA.
18. Replace the P30 Rear Cover removed step 11 and secure the cover with the screws 6 screws. Torque to 10 inch pounds.

**Note:** Do not use an electric screw driver or over tighten the screws. Over tightening may damage the console. This type of damage is not covered under warranty.
19. Replace the P30 Option Cap back cover removed step 12 and secure the cover with the screws 2 screws. Torque to 10 inch pounds.

**Note:** Do not use an electric screw driver or over tighten the screws. Over tightening may damage the console. This type of damage is not covered under warranty.
20. Place the P30 console on the maintenance access hook.
21. Reconnect the Data cable, Auto Stop cable (Treadmill only), Stop Key cable (Treadmill only), Heart Rate ground wire and the CSAFE cable (if in use) from the Upper PCA. **See Diagram 5.6.5.**
22. Reconnect the Heart Rate Cable to the Heart Rate PCA.
23. Replace the the Heart Rate PCA. **See Procedure 5.7, Removing Heart Rate PCA**
24. Replace the access cover with the hardware removed in step 6.
25. Tilt the console back against the mounting plated. While tilting the console back feed the excess cable into weldment tube making sure that the cables will not become pinched.
26. Fasten the console to the dash mounting plate with the four screws removed in step 4. **See Diagram 5.6.2.**
27. Fasten the dash transition cover using the two screws removed in step 3. See Diagram 5.6.1
28. Check treadmill operation per Section Seven.

## Procedure 5.7 – P30 – Replacing Heart Rate PCA

1. Set the treadmill circuit breaker in the off position and unplug the treadmill's line cord from the AC outlet.
2. The PCA's in the console are static sensitive. They can be damaged if proper static prevention equipment is not used. Attach an anti-static wrist strap to your arm, and then connect the ground lead of the wrist strap to the treadmill's frame ground.
3. Remove the HR PCA access panel on the back of the console. See Diagram 5.7.1
4. The HR PCA snaps into its mounting. Press its tabs sideways and remove the HR PCA from its mounting.
5. Disconnect the HR cable and handlebar cable from the HR PCA. See Diagram 5.7.2.
6. Connect the HHHR Grip cable assembly to the upper connector on the HR PCA and the HR PCA Power cable to the lower connector on the replacement HR PCA. See Diagram 5.7.2.
7. Orient the replacement HR PCA so that the side with the protective foam pad is facing out and snap the HR PCA into its mounting.
8. Replace the HR PCA access panel removed in step 3.
9. Check treadmill operation per Section 7

Diagram 5.7.1





Diagram 5.7.2

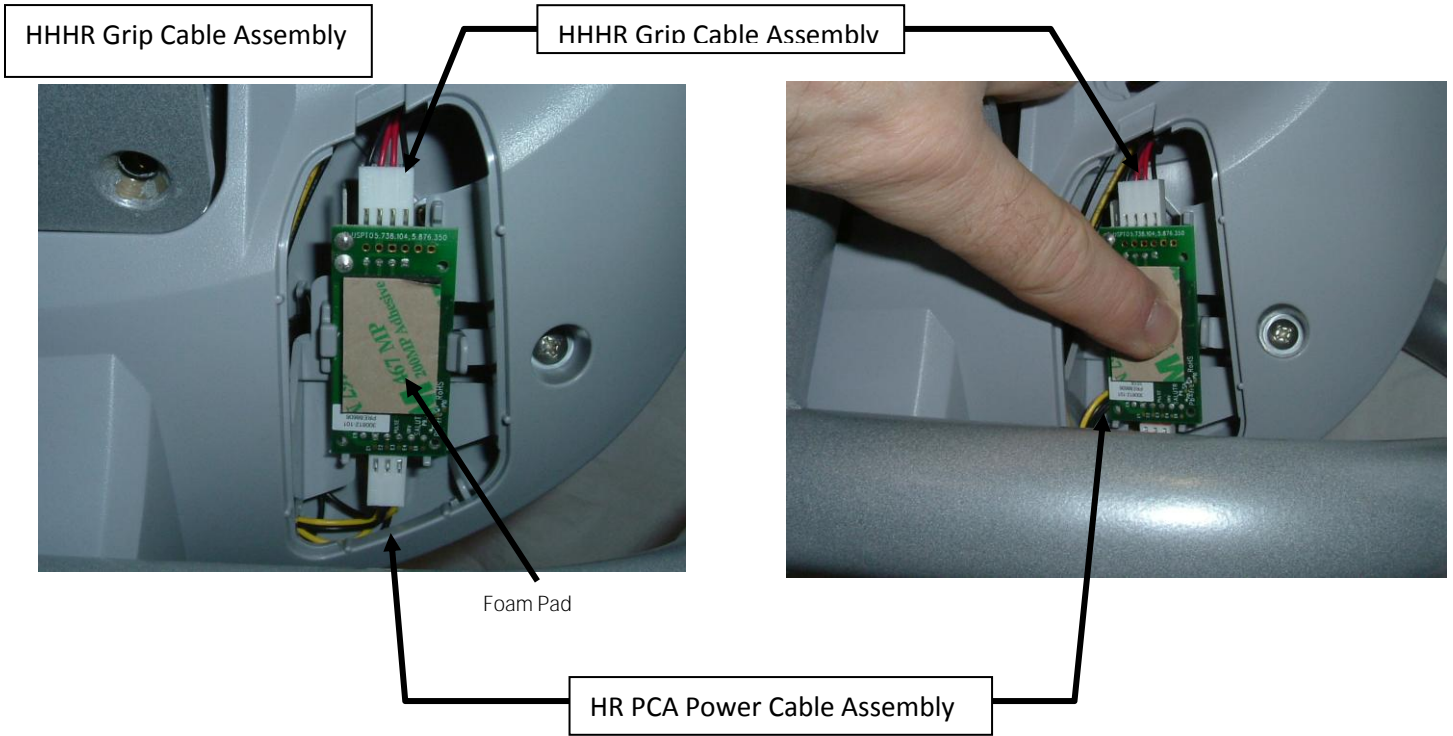

## Procedure 5.8 - Future Content

## Procedure 5.9 - P30 - Flash Programming the Upper PCA

This unit utilizes an upper PCA software system that is capable of on site upper PCA software uploading (re-programming). The software upload may be accomplished with the use of a PDA (palm device) or a laptop computer.

If a palm device is to be used it must use OS software version 3.2 or higher. Currently, we have only tested devices manufactured by Palm, but other manufacturer's palm devices may also function correctly.

If a palm device is to be used, the appropriate software must be available in the palm device. A PDA containing the appropriate software may be ordered from Precor or it may be downloaded to the PDA from your desktop or laptop computer via the hot sync function. With the PDA inserted in the hot sync cradle, download to Precor IFP (in field programmer) directory.

If a laptop computer is to be used, the computer's DB9 serial port will be used for the upload.

### Upload Procedure

1. The P30 must be powered down before the upload procedure can be initiated. Ensure that the P30 has not be used for a sufficient time to allow the lower PCA to completely discharge. The light emitting diode on the lower PCA will go out when the power supply is discharged.
2. If the CSAFE port is in use, temporarily disconnect the RJ-45 cable from the CSAFE port. If the CSAFE port is not in use, temporarily remove the plastic plug from the CSAFE port.
3. Connect the PDA or computer interface cable to the CSAFE port.
4. Select the software file to be uploaded on the palm device or computer.
5. Start pedaling the P30 or power up using the external power supply. When the P30 powers up the upload will commence. You must continue to pedal until the upload is complete, approximately 2 minutes.
6. Stop pedaling or disconnect the external power supply when the upload is complete, and allow the lower PCA to completely discharge. The light emitting diode on the lower PCA will go out when the power supply is discharged.
7. Start pedaling the P30, after it has been allowed to power down, the P30 will now be operating on the newly uploaded software.
8. Thoroughly, check the P30's function per Section Seven.

## Procedure 5.10- Future Content

## Troubleshooting 5.11 – P30 – Troubleshooting the Keypad and the Upper PCA

### Procedure

Note: The white or yellow wire on the cables shown in Diagram 5.5.9 denotes pin 1. When these cables are inserted into their connectors, the white or yellow wire must align with the pin 1 designation on the PCA. If pin 1 is not marked on the PCA refer to Diagram 5.5.9.

1. Set the treadmill's on/off switch in the off position (Treadmill only). Access the upper electronics and machine controls per [Procedure 5.5, steps 1 through 12](#). Place the console on the maintenance mounting hook and reconnect all cables.
2. If the message STUCK KEY is displayed when the unit is turned on for treadmill's or pedaling on the RBK, UBK, AMT, and EFX, skip to step 23.
3. If a key does not function, skip to step 18.
4. If the display does not illuminate, continue with step 5.

Diagram 5.11.1 - Console, Upper PCA, JTAG (J9) Connector

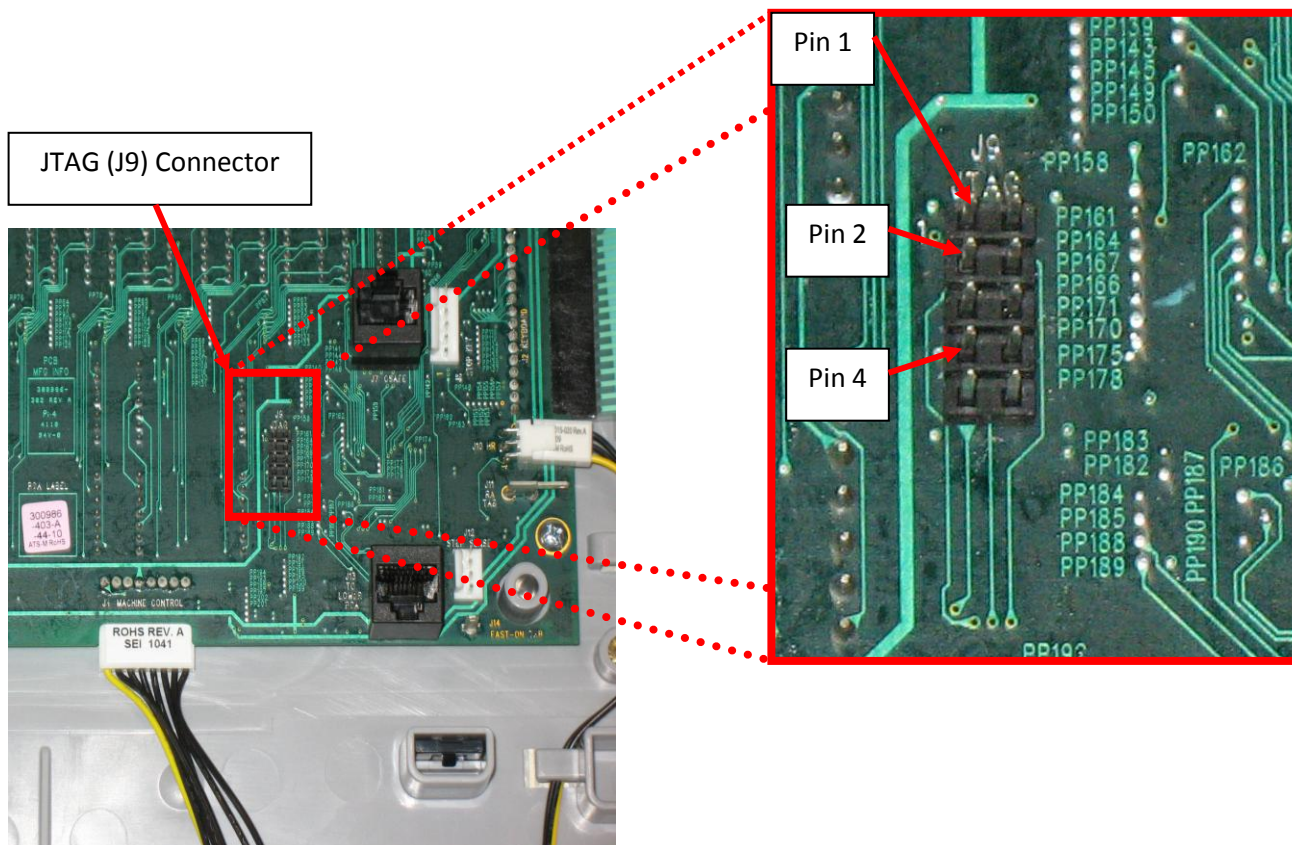
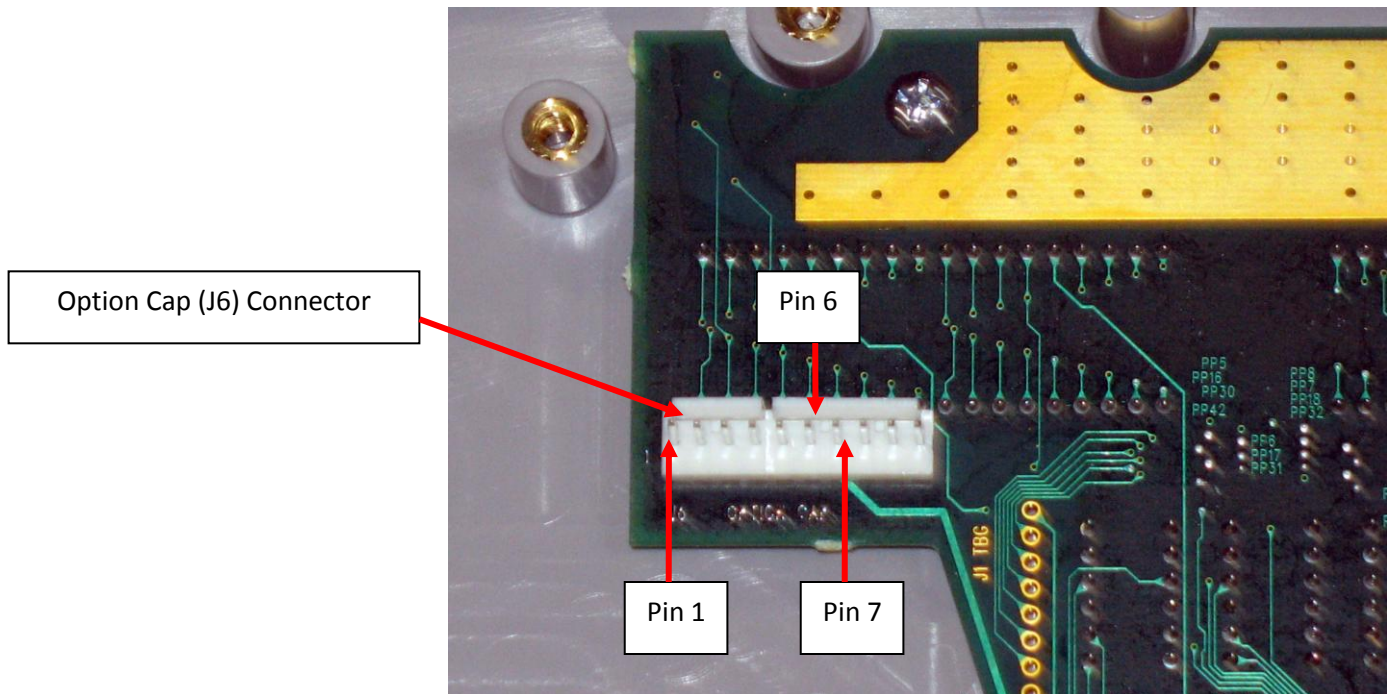

Diagram 5.11.2 - Console, Upper PCA , Option Cap (J6) Connector



5. If the upper PCA is not illuminating, skip to step 12.
6. If the metrics PCA is not illuminating, continue with step 7.
7. Remove the four screws that fasten the metrics PCA to the display face and rotate it so that the front of the PCA is visible. For treadmill's set the on/off switch in the on position for AMT's, EFX's, UBK's, RBK's and CLM's start pedaling.

Note: There are four spacers between the Metric board and the mounting studs. These must be saved and reinstall with the Metric board. If they are not used the Metric board or display face may become damaged.

8. With a DC voltmeter, measure between TP4 (+8V) and TP1 (DGND) for 8 Vdc and between TP2 (+5V) and TP1 (DGND) for 5Vdc. See Diagram 5.11.3

Diagram 5.11.3 - Metrics PCA, Front View

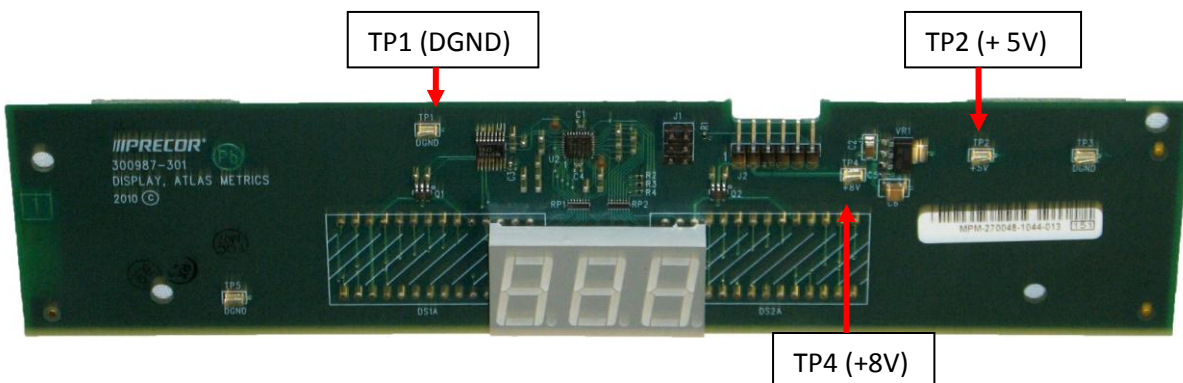

9. If 5 Vdc is not present on TP2 and 8 Vdc is present on TP4, replace the metrics PCA.
10. If 8 Vdc is not present on TP4 and the upper PCA is illuminating normally, replace the cable between the upper PCA and the metrics PCA.
11. If you have performed steps 7 - 10 and the metrics PCA still does not illuminate, contact Precor customer support for assistance.
12. For treadmill's set the on/off switch in the on position, for AMT's, EFX's, UBK's, RBK's and CLM's start pedaling.
13. With a DC voltmeter, measure between pins 2 and 4 of J9 (JTAG Connector) for 5 Vdc and between pins 6 and 7 of J6 (Option Cap) for 8 Vdc.
14. If 5 Vdc is not present on J9 and 8 Vdc is present on J6, replace the upper PCA.
15. If 8 Vdc is not present on J6, temporarily replace the upper PCA to power control module (treadmill's) or Lower PCA (AMT's, EFX's, UBK's, RBK's and CLM's), cable with a known good cable.
16. If the upper PCA illuminates normally, replace the upper PCA to power control module cable permanently. If the upper PCA still does not illuminate, replace the power control module (treadmills) or Lower PCA (AMT's, EFX's, UBK's, RBK's and CLM's).
17. If you have performed steps 12 - 16 and the upper PCA still does not illuminate, contact Precor customer support for assistance.
18. For treadmill's set the on/off switch in the on position for AMT's, EFX's, UBK's, RBK's and CLM's start pedaling.
19. If none of the keys on the display are functioning, check the stop switch cable connection to the upper PCA. (Treadmill Only). If the stop switch is not connected or the stop switch is not functioning, none of the display keys will operate. This feature insures that the treadmill has a functioning stop switch when it is in use (Treadmill Only).
20. If a particular key is not functioning, perform the keyboard test in Procedure 5.2. If the test verifies that the key is not functioning, replace the console face or the machine controls.
21. If the console face or the machine controls has been replaced and the same key or control is still not functioning, replace the upper PCA.
22. If you have performed steps 18 - 22 and the same key is still not functioning, contact Precor customer support for assistance.
23. Remove the keypad cable from the upper PCA. See Diagram 5.5.8.
24. For treadmill's set the on/off switch in the on position for AMT's, EFX's, UBK's, RBK's and CLM's start pedaling.
25. If the **STUCK KEY** message is no longer displayed, replace the console face.
26. Set the treadmill's on/off switch in the off position (Treadmills Only).

27. Remove the Machine Control cable from the upper PCA.
28. For treadmill's set the on/off switch in the on position for AMT's, EFX's, UBK's, RBK's and CLM's start pedaling.
29. If the **STUCK KEY** message is no longer displayed, replace the machine Controls assembly.
30. If the **STUCK KEY** is still being displayed with the keyboard cable disconnected, replace the upper PCA.
31. If you have performed steps 23 - 30 and the **STUCK KEY** message is still being displayed, contact Precor customer support for assistance.



## Troubleshooting 5.12 - P30 - Troubleshooting Handheld Heart Rate

### Circuit Description

The hand held heart rate system is actually a dual system, that is, it can accept a heart rate signal from either the hand held heart rate contacts on the unit's handlebar or from a Polar heart rate chest strap transmitter. The PCA is configured for hand held priority. That is, if both a chest strap and hand heart rate signal are being received, the system will accept the hand held signal and ignore the chest strap signal. If a hand held signal is not being received, the system will accept the chest strap signal.

### Note:

There are four typical failure modes for the hand held/chest strap heart rate system. They are: hand held is normal - no chest strap reading; no hand held reading - chest strap normal; no hand held or chest strap reading or constant or intermittent readings when neither hand held or chest strap are in use.

Diagram 5.12.1 - Hand held/chest strap heart rate PCA

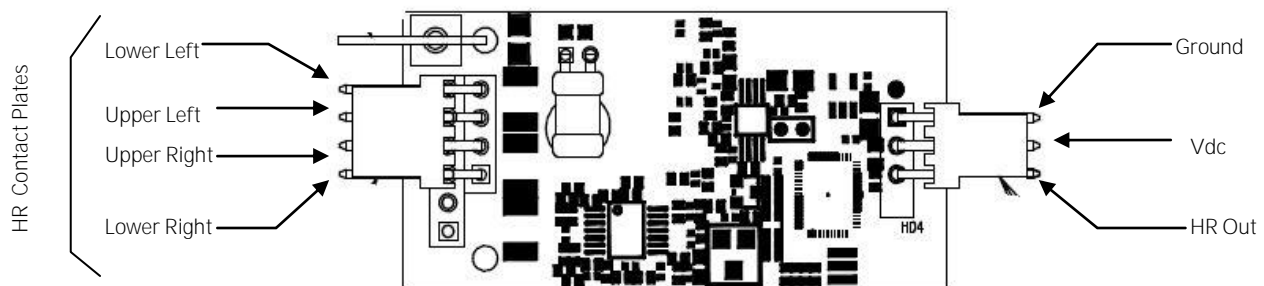

### Normal hand held reading - No chest strap reading

1. Access the diagnostic program (Procedure 5.1). Advance to the heart rate display portion of the diagnostic program. Verify that a chest strap signal is not being accepted with either a Polar heart rate test transmitter or a known good chest strap transmitter. If this reading is good, skip to step 3.
2. Using a known good Polar heart rate chest strap, verify that the heart rate operates with the known good chest strap. If the known good Polar chest strap does correct the problem, replace the original chest strap transmitter.
3. If the above procedures did not correct the problem, replace the heart rate PCA.

#### No hand held reading - Normal chest strap reading

4. Access the diagnostic program (Procedure 5.1). Advance to the heart rate display portion of the diagnostic program. Verify that a hand held signal is not being accepted by firmly grasping both the right and left hand held contacts on the handlebars. Cover as much of the top and bottom contact surface area with your hands as possible (without moving your hands), you should receive a heart rate reading within ten seconds.
5. If the hand held signal is now being accepted, something in the near vicinity is radiating RF (radio frequency) energy that is being received by the chest strap portion of the heart rate PCA.
6. If a hand held signal still not being accepted, skip to step 8.
7. Replace the heart rate PCA with a 300812-101 (or higher) heart rate PCA. 300812-101 and higher versions of heart rate PCA are less susceptible to radiated RF energy.
8. Access the diagnostic program (Procedure 5.1). Advance to the heart rate display portion of the diagnostic program. Verify that a hand held signal is not being accepted by firmly grasping both the right and left hand held contacts with the opposite hands, right hand on the left handlebar contacts and left hand on the right handlebar contacts. Cover as much of the top and bottom contact surface area with your hands as possible, you should receive a heart rate reading within ten seconds. If a hand held signal is still not being accepted, skip to step 10.
9. If a hand held signal was accepted in step 8, the hand held contact wiring is reversed. The harness that connects to the hand held contacts in the handlebar is segregated into two groups. One group has blue shrink wrap around it and the other group has black shrink wrap around it. The blue group must go to the right hand contacts and the black group must go to the left hand contacts. If necessary, rewire the hand held contacts as described above and test as described in step 4.
10. If the wiring is correct, refer to Diagram 5.12.1 for the following measurements. With an ohmmeter measure between the lower right contact pin on the J1 connector and the lower right hand held heart rate contact on the handlebar. The reading should be 1  $\Omega$  or less. Measure between the upper right contact pin on the J1 connector and the upper right hand held heart rate contact on the handlebar. The reading should be 1  $\Omega$  or less. Measure between the upper left contact pin on the J1 connector and the upper left hand held heart rate contact on the handlebar. The reading should be 1  $\Omega$  or less. Measure between the lower left contact pin on the J1 connector and the lower left hand held heart rate contact on the handlebar. The reading should be 1  $\Omega$  or less. If any of the above readings are greater than 1  $\Omega$ , replace the heart rate PCA to handlebar wire harness.

No hand held reading - No chest strap reading

11. Access the diagnostic program (Procedure 5.1). Advance to the heart rate display portion of the diagnostic program. Verify that neither a chest strap signal or a hand held signal is being accepted with either a heart rate test transmitter or a chest strap transmitter.
12. Check the plug/connector connections on both the heart rate PCA (J4), and upper PCA (J1).
13. If neither a chest strap signal or a hand held signal is being accepted, measure between the ground and 5 Vdc pins on J4 for 5 Vdc. If 5 Vdc is present, replace the heart rate PCA.
14. If 5 Vdc is not present, remove the connector from J4 of the heart rate PCA. Measure between the ground and 5 Vdc pins of the connector (just removed from the heart rate PCA) for 5 Vdc. If 5 Vdc is present, replace the heart rate PCA. If the 5 Vdc is not present, measure between the corresponding pins of J1 on the upper PCA (red and black wires). If 5 Vdc is not present replace the upper PCA. If 5 Vdc is present, replace the upper PCA to heart rate PCA cable.
15. Constant or intermittent readings when neither the hand held or chest strap is in use.
16. Verify that a ferrite core is clamped around the heart rate PCA to upper PCA cable. Constant or intermittent heart rate readings when neither heart rate system is in use is caused by something in the near vicinity radiating RF energy that is being received by the chest strap portion of the heart rate PCA. Replace the heart rate PCA with a 300812-101 (or higher) heart rate PCA. 300812-101 and higher versions of heart rate PCA are less susceptible to radiated RF energy.

## Troubleshooting 5.13 - Upper Display does not Illuminate

1. Because this is self powered unit, the display will not illuminate until it is used or the optional external power supply is equipped. If the optional external power supply is equipped, the display should be constantly illuminated.
2. If the optional external power supply is not equipped, skip to step 5.
3. Disconnect the optional external power supply from the AMT and measure between the inner and outer sleeves of the power supply's output jack with a DC voltmeter. You should measure approximately 18 VDC.
4. If the voltage measured in step 3 was significantly low, replace the optional external power supply. If the voltage measured in step 3 was 0 Vdc, disconnect external power supply from its AC outlet and measure the voltage at the AC outlet. If the AC outlet voltage is normal replace the optional external power supply. If the AC outlet voltage is significantly low or 0 Vdc, the AC system must be inspected by an electrician.
5. Troubleshoot the generator per Procedure 9.2.
6. If the generator was found to be good, the problem will be in either the lower PCA, upper PCA or the upper to lower PCA interconnect cable.

### Warning

Because this is a self powered unit, it will either be necessary to either equip the unit with the optional external power supply or have an assistant pedal on the unit while voltage measurements are being taken. Because of the danger of working on the unit while it is in motion using the optional external power supply is strongly recommended.

7. Remove the right side cover and disconnect the interconnect cable from the lower PCA.
8. The following voltage reading must be taken while the unit is in motion. Extreme care must be taken to keep meter wires, hands, etc. clear of all moving parts. Using a DC voltmeter, measure the voltage between TP24 (7.5V) and TP14 (DGND). Refer to Diagram 5.14.1. The voltage measured should be approximately 7.5 Vdc. If the voltage is significantly low, replace the lower PCA. Additionally, the DS1 and DS2 LED's should illuminate.
9. Reconnect the interconnect cable to the lower PCA and repeat the voltage measurement in step 8. The voltage measured should be approximately 7.5 Vdc. If the voltage is significantly low, the problem is in the upper PCA or the upper to lower PCA interconnect cables.

Diagram 5.13.1 - Partial View of Lower PCA

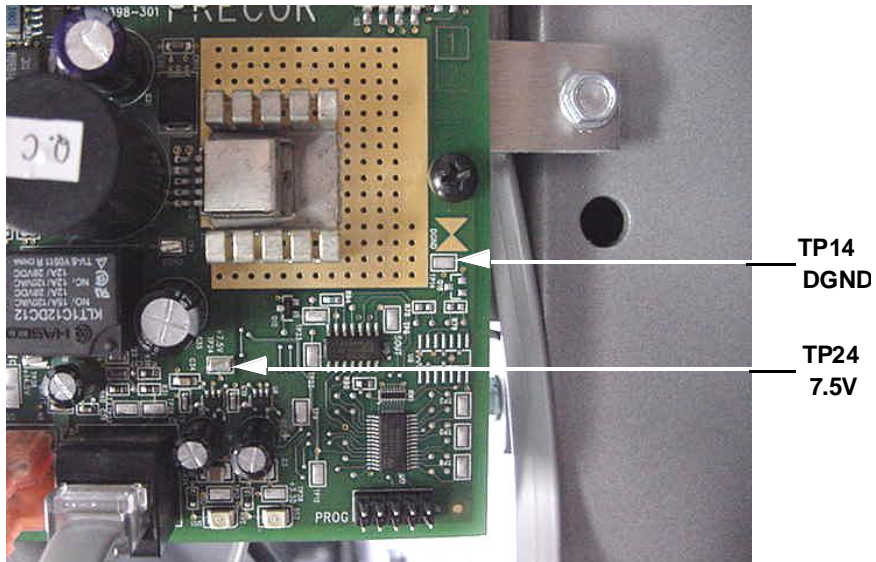

10. Troubleshoot the upper to lower PCA interconnect cables per Procedure 9.1.
11. If the upper to lower interconnect cable is found to be good, replace the upper PCA.
12. If you have performed all of the above tests and are unable to resolve the problem, contact Precor customer support.

## Section Six - P20 Console - AMT



## Procedure 6.1 - P20 - Accessing the Diagnostic Software

The P20 Console diagnostic software consists of the following modes:

- Beeper Test
- Keyboard Test
- LCD Test
- Heart Rate Test
- Machine Test
  - Brake Test
  - RPM Test
  - Battery Test
  - Stride Position Test

### Procedure:

1. Use the:
  - INPUT UP▲ and INPUT DOWN▼ keys to move through the different tests.
  - GO key to select the test needed.
  - WORKOUTS/PROGRAMS key to back up one level until reaching Banner state.
  - PAUSE/RESET key to return the unit to Banner state from anywhere in the menus.
2. See Diagram 6.1.1 and Diagnostic Menus - Table

Diagram 6.1 .1 - P20 Console



## Diagnostic Menus - Table

Test Type	Action	Description
Diagnostic Software	At the Banner press PAUSE/RESET, ENTER, PROGRAMS, INPUT DOWN▼, INPUT UP▲, ENTER, INPUT DOWN▼, INPUT UP▲, and PROGRAMS sequentially.	BEEPER TEST will be displayed.
Beeper Test	Press the GO key to select the test.	The display will prompt the user to test the beeper sound.
	Press the GO key to start the test.	This test will send an audible sound to the speaker mounted in the headphone jack.
	Press the ENTER key to stop the test.	
	Press the WORKOUTS/PROGRAMS key to exit the beeper test.	
Keyboard Test	Press the ▼ key to go to the next test.	KEYBOARD TEST will scroll across the display.
	Press the GO key.	A representation of all of the keys on the console will be displayed. Pressing a key on the console will cause the illuminated representation of that key to turn off. Press all of the keys on the console to ensure that all of the keys are functioning. The keyboard test will exit when all the keys have been pressed.
	Press the ▼ key to go to the next test.	LCD TEST will scroll across the display
LCD Test	Press the GO key to select the test.	The unit will test all the different sections of LCD display screen then all sections on, advancing through each section. Check the display to ensure that all LED segments are illuminated.
	Press the WORKOUTS/PROGRAMS key to exit the LCD test.	
	Press the ▼ key to go to the next test.	HEART RATE TEST will scroll across the display
Heart Rate Test	Press the GO key to select the test.	Grasp both of the heart rate grips on the handlebar, after a couple of seconds the heart rate will be displayed in the heart rate and smart rate displays.  Use chest strap transmitter or a wireless heart rate transmitter to test the wireless heart rate function, after a couple of seconds the heart rate will be displayed in the heart rate and smart rate displays.
	Press the WORKOUTS/PROGRAMS key to exit the Heart Rate test.	
	Press the ▼ key to go to the next test.	MACHINE TEST will scroll across the display.
Machine Test	You may now proceed to the BRAKE test, RPM test, BATTERY test, STRIDE POSITION test, or STRIDE COUNT RESET. Press the ▼, key until the desired test is displayed.	
	Press the ▼ key to go to the next test.	BRAKE TEST will scroll across the display.
	Press the GO key to select the test.	The brake power bits information will be displayed in the Distance Field. This information is used to help diagnose problems with the Eddy Current Magnet.
	Press the WORKOUTS/PROGRAMS key to exit the Brake test.	
	Press the ▼ key to go to the next test.	RPM TEST will scroll across the display.
	Press the GO key to select the test.	Rotation count is determined by a zero crossing from one phase of the generator and is represented as RPM in service mode. The count in service mode is real time and should go to zero if you quit pedaling, which can help diagnose stride count irregularities.



	Press the WORKOUTS/PROGRAMS key to exit the RPM test.	
	Press the ▼ key to go to the next test.	BATTERY TEST will scroll across the display.
	<b>Press the GO key to select the test.</b>	The battery voltage will be displayed.
	Press the WORKOUTS/PROGRAMS key to exit the Battery test.	
	Press the ▼ key to go to the next test.	STRIDE POSITION TEST will scroll across the display.
	<b>Press the GO key to select the test.</b>	The actual <u>horizontal</u> stride position will be displayed with HI (Highest value during the test) and the LO (Lowest value during the test). The AMT has a range of 0-40.
	Press the WORKOUTS/PROGRAMS key to exit the Stride Position test.	
	Press the WORKOUTS/PROGRAMS key to exit the Machine test.	
	Press the WORKOUTS/PROGRAMS key to exit Diagnostic Menu.	

## Procedure 6.2 - P20 - Displaying Information

The information display will access the following data:

- Odometer
- Hour Meter
- U-Boot Software
- U-Base Software
- Lower Software
- Usage log
- Error Log

Procedure:

1. Use the:

- INPUT UP▲ and INPUT DOWN▼ keys to move though the different information.
- GO key to select the information.
- WORKOUT/PROGRAMS key to back up one level until reaching Banner state.
- PAUSE/RESET key to return the unit to Banner state from anywhere in the menus.

Displaying Information Menu - Table

Displayed Information	Action	Description
Odometer	<b>At the Banner press PAUSE/RESET, INPUT UP▲, and ENTER sequentially.</b>	ODOMETER will be displayed.
	Press the GO key to select.	The odometer, stored in EEPROM, is updated every half hour, at the end of an exercise session, and when an error occurs. This includes both total strides and distance. The odometer distance is the actual measured distance, determined by the stride length (which is different than the displayed perceived distance (based off calories/min) seen during a workout. This measured distance value is stored in 1/10 miles, but displayed in whole miles.
	Press the WORKOUTS/PROGRAMS key to exit the Odometer.	
Hour Meter	Press the ▼ key to go to Hour Meter.	HOUR METER will scroll across the display.
	Press the GO key to select.	The operating time of the unit will be displayed as <b>12345 HOURS</b> . The operating time is defined as total amount of time that the unit has operated in program modes. The hour meter is also used to provide the time stamp for the error code log.
	Press the WORKOUTS/PROGRAMS key to exit the Hour Meter.	
U-Boot Software	Press the ▼ key to go to U-Boot Software.	U-Boot Software will scroll across the display

	Press the GO key to select.	This displays the installed version of upper boot software. The boot software is used to upload new software into the upper display PCA.  The software part number will be displayed as <b>XXXXX-XXX</b> .
	Press the WORKOUTS/PROGRAMS key to exit U-Boot Software.	
U-Base Software	Press the ▼ key to go to U-Base Software.	U-BASE SOFTWARE will scroll across the display.
	Press the GO key to select.	This displays the installed version of upper PCA software.  The software part number will be displayed as <b>XXXXX-XXX</b> .
	Press the WORKOUTS/PROGRAMS key to exit the U-Base Software.	
Lower Software	Press the ▼ key to go to Lower Software.	LOWER SOFTWARE will scroll across the display.
	Press the GO key to select.	This displays the installed version of lower PCA software.  The software part number will be displayed as <b>XXXXX-XXX</b> .
	Press the WORKOUTS/PROGRAMS key to exit Lower Software.	
Usage Log	Press the ▼ key to go to Usage Log.	USAGE LOG will scroll across the display.
	Press the GO key to select.	Use the ▲, ▼ keys to move through the list of programs. A message will scroll describing the program, the number of times and the number of minutes the program was used.
	Press the WORKOUTS/PROGRAMS key to exit the Usage Log.	
Error Log	Press the ▼ key to go to Error Log.	ERROR LOG will scroll across the display.
	Press the GO key to select.	Use the ▲, ▼ keys to move through the list of errors. The error messages will list the error name, the odometer reading when the error occurred, the hour meter when the error occurred and the drive motor current reading when the error occurred.  The error log holds a maximum of 30 errors. If there is an error, this is where it will be stored; otherwise, it should show 0 ERRORS. When the error log has stored the maximum recorded errors, any additional error will be logged as the most recent and the oldest error will be erased from the log.  If you wish to clear the error log, press and hold the GO key for 5 seconds. The message <b>ERROR LOG CLEAR</b> will be displayed.  Quick Error Log Access - When in the Banner state the RESET key is pressed for 5 seconds, the display will take you directly to the Error Log, if the Log has Errors. If there are no errors, STUCK KEY is displayed on the STD, and then it goes back to Banner state when the key is released.
	Press the RESET key to exit to the Banner.	

## Procedure 6.3 – P20 – Setting Club Parameters

This procedure allows you to change the following club settings:

- Select Language
- Select Units of Measure
- Set Default Workout Time
- Set Max Workout Time
- Set Max Resistance
- Set Max Crossramp
- Set Max Pause Time
- Set Cool Down Time

### Procedure

1. Use the:
  - INPUT UP▲ and INPUT DOWN▼ keys to move through the different Club Settings.
  - GO key to select the setting.
  - WORKOUTS/PROGRAMS key to back up one level until reaching Banner state.
  - PAUSE/RESET key to return the unit to Banner state from anywhere in the menus.

### Club Settings Menu - Table

Setting Type	Action	Description
Set Language	At the Banner press PAUSE/RESET, ENTER, INPUT UP▲, WORKOUTS/PROGRAMS, ENTER, INPUT UP▲, and ENTER keys <b>sequentially</b> .	SET LANGUAGE will be displayed.
	Press the GO key to select the setting.	Available choices of languages will be displayed. The INPUT keys will allow scrolling through the available languages.
	Press the WORKOUTS/PROGRAMS key to exit Set Language.	
Set Unit of Measure	Press the ▼ key to go to the next setting.	SET UNIT OF MEASURE will scroll across the display.
	Press the GO key to select setting.	Use the INPUT UP▲ and INPUT DOWN▼ keys to toggle between U.S (miles per hour) and METRIC (kilometers per hour).
	Press the WORKOUTS/PROGRAMS key to exit Set Units of Measure.	
Set Default Workout Time	Press the ▼ key to go to the next setting.	SET DEFAULT WORKOUT TIME will scroll across the display
	Press the GO key to select the Default Workout Time.	Use INPUT UP▲ or INPUT DOWN▼ key to toggle between ON and OFF. When set to ON, 30 will be displayed, use INPUT UP▲ or INPUT DOWN ▼ key to increase or decrease time. <ul style="list-style-type: none"> <li>• When set to OFF, programs time will be the value in MAX Workout Time</li> </ul>

	Press ENTER key to select.	
	Press the WORKOUTS/PROGRAMS key to exit the Set Default Workout Time.	
Set Max Workout Time	Press the ▼ key to go to the next setting.	SET MAX WORKOUT TIME will scroll across the display
	<b>Press the GO key to select setting.</b>	Use the INPUT UP▲ or INPUT DOWN▼ keys to select the maximum time a user can remain in a program. The range is 1 to 90 minutes, if 90 minutes is selected, No Limit time option will be available.
	Press the WORKOUTS/PROGRAMS key to exit the Set Max Workout Time.	
Set Max Resistance	Press the ▼ key to go to the next setting.	SET MAX RESISTANCE will scroll across the display.
	<b>Press the GO key to select setting.</b>	Use the INPUT UP▲ or INPUT DOWN▼ keys to select the maximum resistance level. The range for resistance level is 1-20
	Press the WORKOUTS/PROGRAMS key to exit Set Max Resistance.	
Set Max Crossramp	Press the ▼ key to go to the next setting.	SET MAX CROSSRAMP will scroll across the display.
	<b>Press the GO key to select setting.</b>	Use the INPUT UP▲ or INPUT DOWN▼ keys to select the maximum crossramp level. The range for crossramp level is 1-20
	Press the WORKOUTS/PROGRAMS key to exit Set Max Crossramp.	
Set Max Pause Time	Press the ▼ key to go to the next setting.	Set Max Pause Time will scroll across the display.
	<b>Press the GO key to select setting.</b>	Use the INPUT UP▲ or INPUT DOWN▼ keys to select the maximum pause time.  *The available options are: <ul style="list-style-type: none"> <li>• None (Meaning it will stay paused indefinitely until the person pushes Reset or resumes their workout. Infinite)</li> <li>• 5 seconds</li> <li>• 30 seconds (default)</li> <li>• 1 minute</li> <li>• 2 minutes</li> <li>• 5 minutes</li> </ul> *Note: The 30 second default time will be the longest length of Pause time available unless the optional external power supply is being used.
	Press the WORKOUTS/PROGRAMS key to exit Set Max Pause Time.	
Set Max Cool Down Time	Press the ▼ key to go to the next setting.	SET MAX COOL DOWN TIME will scroll across the display.
	<b>Press the GO key to select setting.</b>	Use the INPUT UP▲ or INPUT DOWN▼ keys to select the maximum pause time. The range is 0-5 minutes.
	Press the WORKOUTS/PROGRAMS key to exit Set Max Cool Down Time.	
	Press the WORKOUTS/PROGRAMS key to exit Club Settings Menu.	

## Procedure 6.4 – P20 – Documenting Software Problems

When a problem is found with the software in the upper or lower PCA, record the information listed below.

When a problem occurs, record the following information:

- Model and serial number
- Software version number
- Program number running when the problem occurred

A description of:

- What happened or failed to happen.
- The action taken by the user just before the problem occurred.
- Problem-related information (such as how far into the program the problem occurred, the work level being used when the problem occurred, error code displayed, etc.).
- The frequency of occurrence.

## Procedure 6.5 - P20 - Replacing Upper PCA

1. Set the treadmill circuit breaker in the off position and unplug the treadmill's line cord from the AC outlet.  
(Treadmill Only)
2. The PCA's in the console are static sensitive. They can be damaged if proper static prevention equipment is not used. Attach an anti-static wrist strap to your arm, and then connect the ground lead of the wrist strap to the treadmill's frame ground.
3. Remove the two screws that fasten the dash transition cover and remove the cover. See Diagram 6.5.1

Diagram 6.5.1 - Dash Transition Cover (Treadmill Only)



4. Remove the four screws that fasten the console to the dash mounting plate. See Diagram 6.5.2.

Diagram 6.5.2 - Dash Mounting Plate

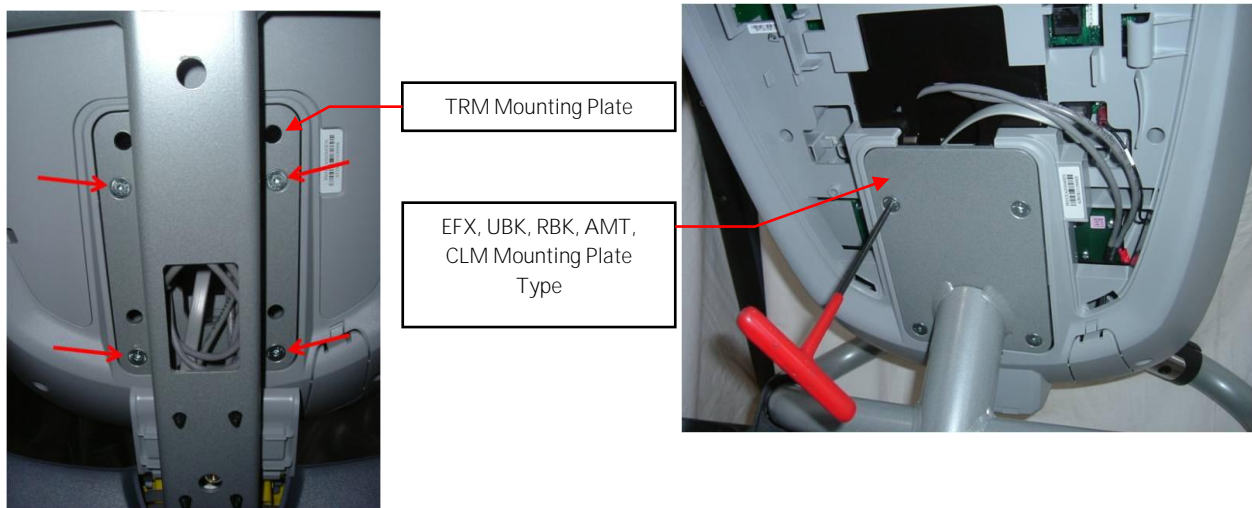

5. Remove the two screws that fasten the access panel to the console. See Diagram 6.5.3

Diagram 6.5.3 – Console Access Panel



6. Remove access panel:
  - a. Treadmills: Lift the console off the maintenance and then position the console so that the back panel is accessible and remove the back cover.
  - b. AMT's, EFX's, CLM's, UBK's, and RBK's: Tilt the console forward on the maintenance access hook on the dash weldment and remove the back. See Diagram 5.5.4.

Diagram 6.5.4 – Maintenance Access Hook



7. Disconnect the Data cable, Auto Stop cable (Treadmill only), Stop Key cable (Treadmill only), Hand Held HR Cable, Earth Ground wire and the Wireless HR Cable from the Upper PCA. See Diagram 6.5.5. Remove the console from the maintenance access hook and place it on a flat work surface.



Diagram 6.5.5 - P20 Cable Connectors

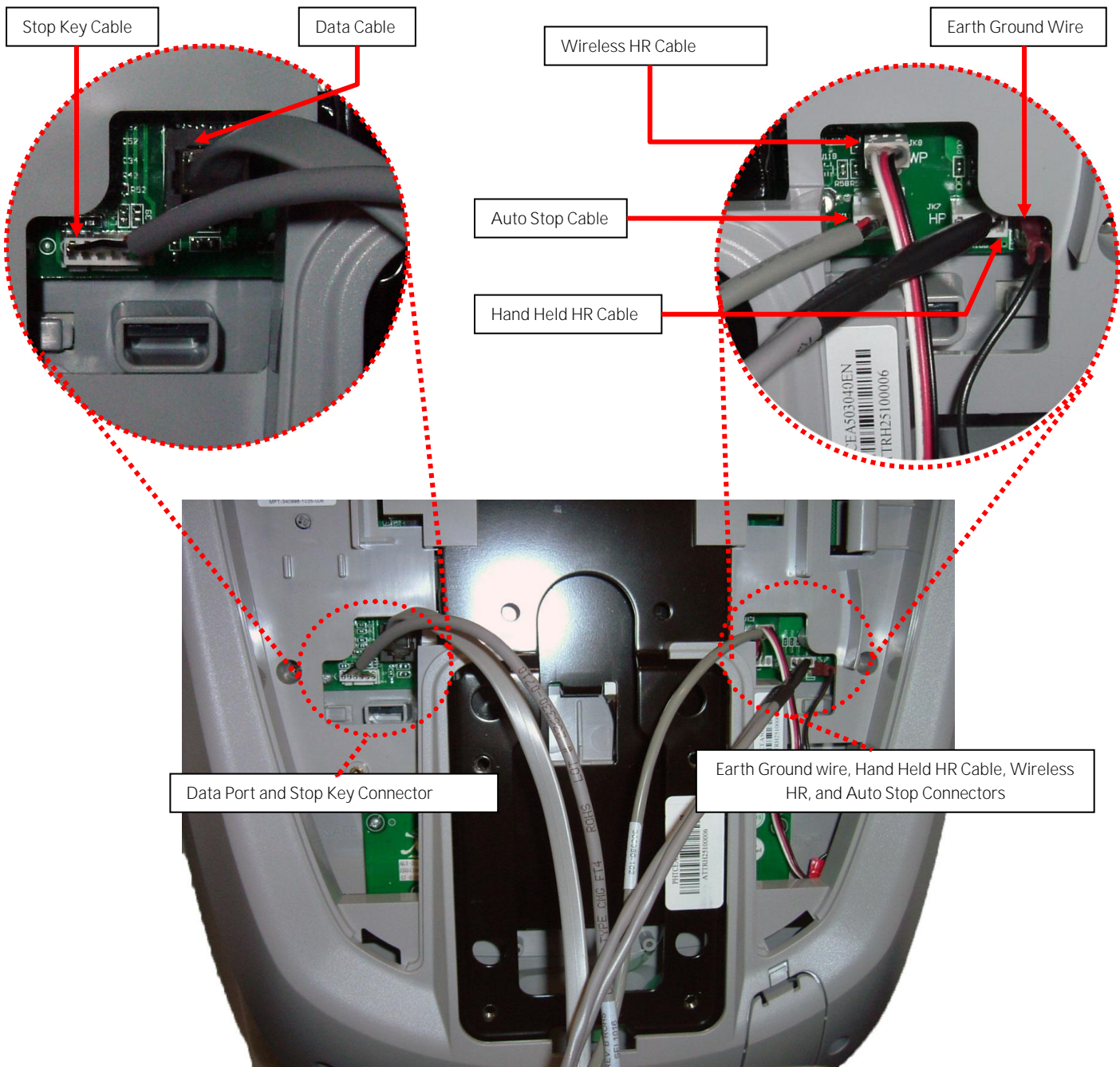

8. Remove the two screws that fasten the back cover to the option cap and remove the cover. See Diagram 6.5.6

Diagram 6.5.6 – Option Cap Back Cover



9. Remove the 6 screws that fasten the rear cover from the console and remove. See Diagram 6.5.7.

Diagram 6.5.7 – Rear Console Cover

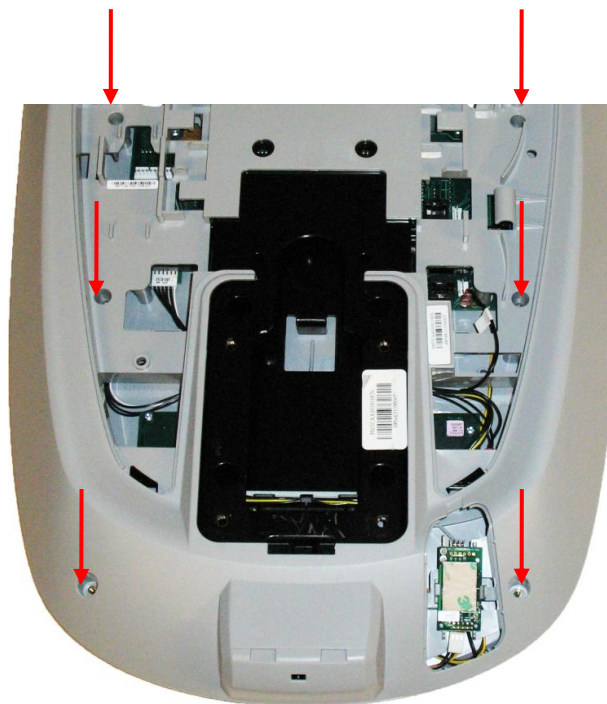

10. Disconnect the Metric cable (JK6), Machine Controls cable (JK12), Option Cap cable (JK5, if applicable), and Keypad Metric cable (JK1) from the Upper PCA board. See Diagram 6.5.8.
11. Remove the four screws that fasten the Upper PCA board to the console and remove the Upper PCA.

Diagram 6.5.8 - P20 Upper PCA & Metric Board

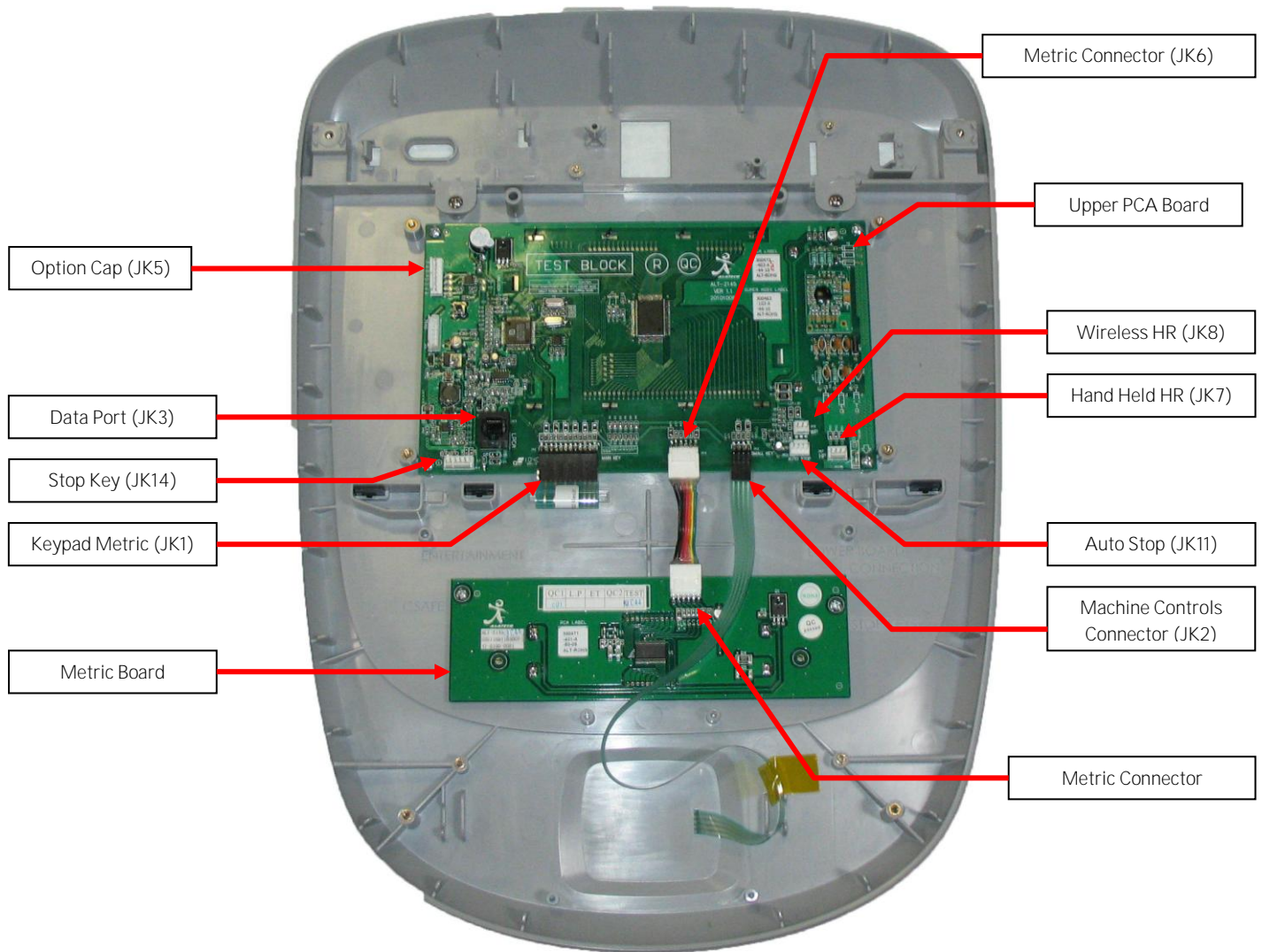

12. Install the replacement upper PCA into the console using the four screws removed in step 12. Torque to 10 inch pounds.

Note: Do not use an electric screw driver or over tighten the screws. Over tightening may damage the console. This type of damage is not covered under warranty.

13. The green wire in the Metrics cable indicate pin 1 and the symbol (▽) indicates Pin 1 on the PCA. Align the green wire with the pin 1 markings on the upper PCA. See Diagram 6.5.9

Note: If pin 1 is not marked on the Upper PCA refer to Diagram 6.5.9.

Diagram 6.5.9 – P20 PCA – Pin 1 Reference

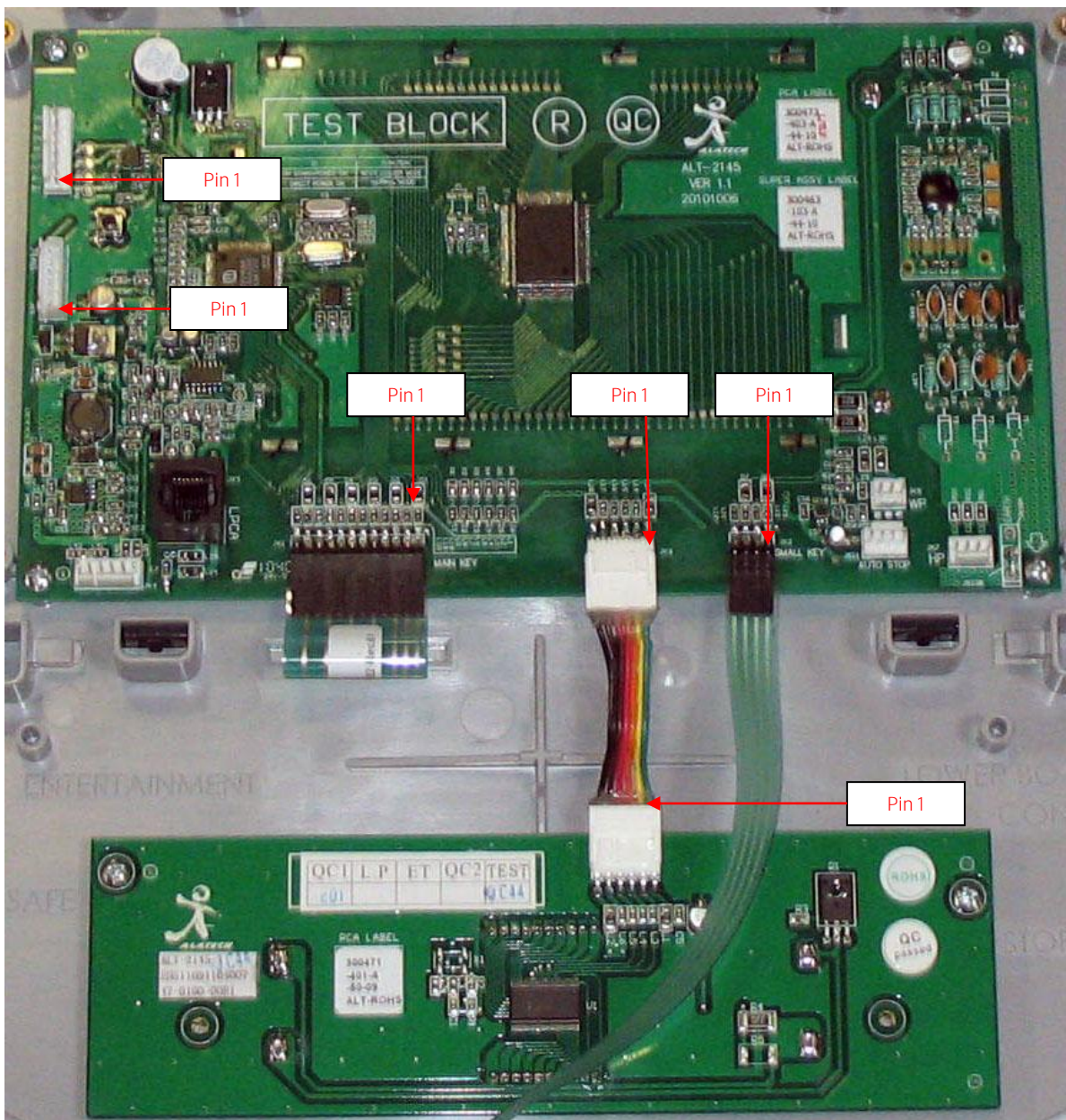

14. Connect the Metrics cable, Machine Controls cable, Keypad Metric cable, and Option Cap cable (if applicable) to the Upper PCA.
15. Replace the P20 Rear Cover removed step 10 and secure the cover with the screws 6 screws. Torque to 10 inch pounds.

Note: Do not use an electric screw driver or over tighten the screws. Over tightening may damage the console. This type of damage is not covered under warranty.
16. Replace the P30 Option Cap back cover removed step 9 and secure the cover with the screws 2 screws. Torque to 10 inch pounds.

Note: Do not use an electric screw driver or over tighten the screws. Over tightening may damage the console. This type of damage is not covered under warranty.
17. Place the P20 console on the maintenance access hook.
18. Reconnect the Data cable, Auto Stop cable (Treadmill only), Stop Key cable (Treadmill only), Hand Held HR cable, Wireless HR cable, and the Earth Ground wire and to the Upper PCA. See Diagram 6.5.5.
19. Replace the access cover with the hardware removed in step 5.
20. Tilt the console back against the mounting plated. While tilting the console back feed the excess cable into weldment tube making sure that the cables will not become pinched.
21. Fasten the console to the dash mounting plate with the four screws removed in step 4. See Diagram 6.5.2.
22. Fasten the dash transition cover using the two screws removed in step 3. See Diagram 6.5.1
23. Check treadmill operation per Section Seven.

## Procedure 6.6 – P20 – Replacing the Metric Board

1. Set the treadmill circuit breaker in the off position and unplug the treadmill's line cord from the AC outlet. (Treadmill only)
2. The PCA's in the console are static sensitive. They can be damaged if proper static prevention equipment is not used. Attach an anti-static wrist strap to your arm, and then connect the ground lead of the wrist strap to the treadmill's frame ground.
3. Remove the two screws that fasten the dash transition cover and remove the cover. See Diagram 6.6.1

Diagram 6.6.1 – Dash Transition Cover (Treadmill only)



4. Remove the four screws that fasten the console to the dash mounting plate. See Diagram 6.6.2.
5. Diagram 6.6.2 – Dash Mounting Plate

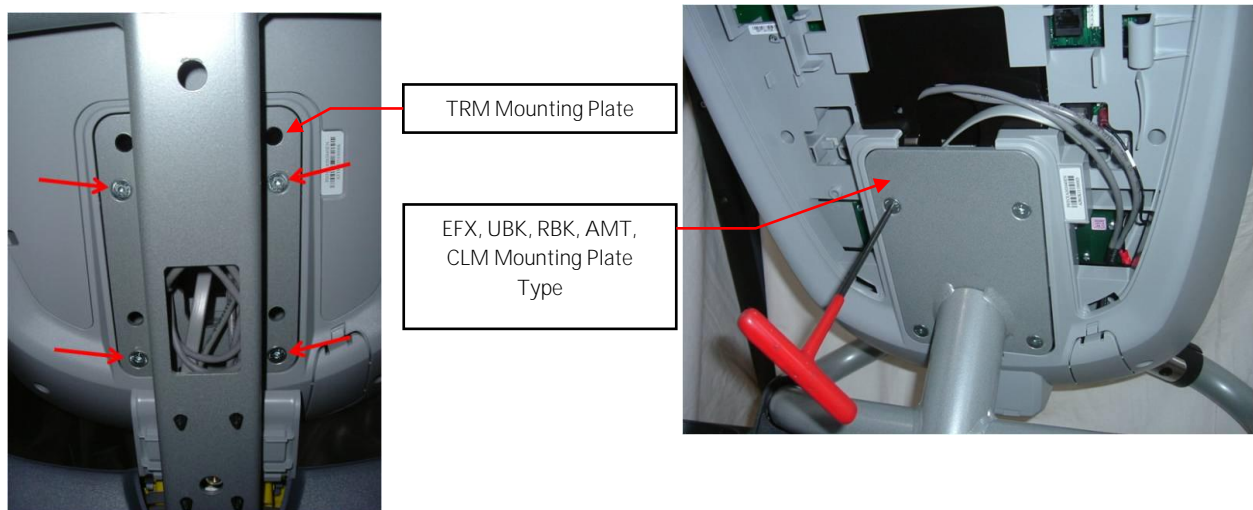

6. Remove the two screws that fasten the access panel to the console. See Diagram 6.6.3

Diagram 6.6.3 – Console Access Panel



7. Remove Access panel:
  - a. Treadmills: Lift the console off the maintenance hook and then position the console so that the back panel is accessible and remove the back cover.
  - b. AMT's, EFX's, CLM's, UBK's, and RBK's: Tilt the console forward on the maintenance access hook on the dash weldment and remove the back.

See Diagram 6.6.4. Diagram 6.6.4 – Maintenance Access Hook



8. Disconnect the Data cable, Auto Stop cable (Treadmill only), Stop Key cable (Treadmill only), Hand Held HR Cable, Earth Ground wire and the Wireless HR Cable from the Upper PCA. See Diagram 6.6.5. Remove the console from the maintenance access hook and place it on a flat work surface.

Diagram 6.6.5 – P20 Cable Connectors

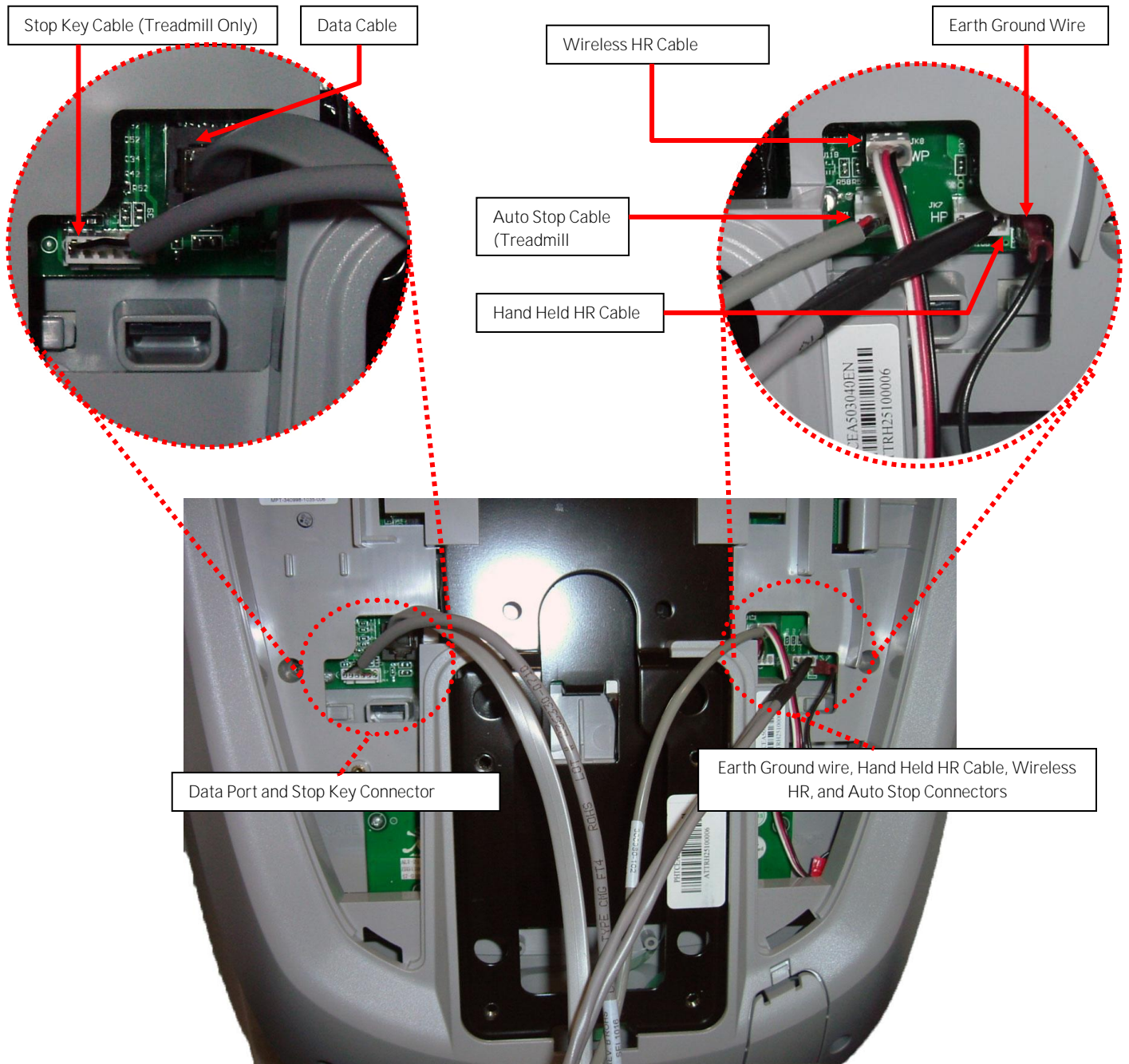

9. Remove the two screws that fasten the back cover to the option cap and remove the cover. See Diagram 6.6.6



**Diagram 6.6.6 – Option Cap Back Cover**

10. Remove the 6 screws that fasten the rear cover from the console and remove. See Diagram 6.6.7.

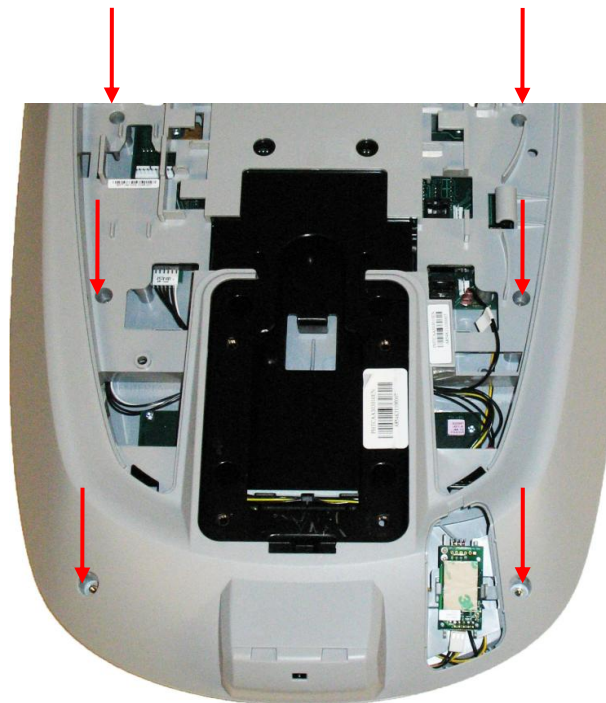
**Diagram 6.6.7 – Rear Console Cover**

11. Disconnect the Metric cable from the Metric PCA board. See Diagram 6.6.8.
12. Remove the four screws that fasten the Metric PCA board to the console and remove the Metric PCA and the four spacers.

Diagram 6.6.8 – P20 Upper PCA &amp; Metric Board

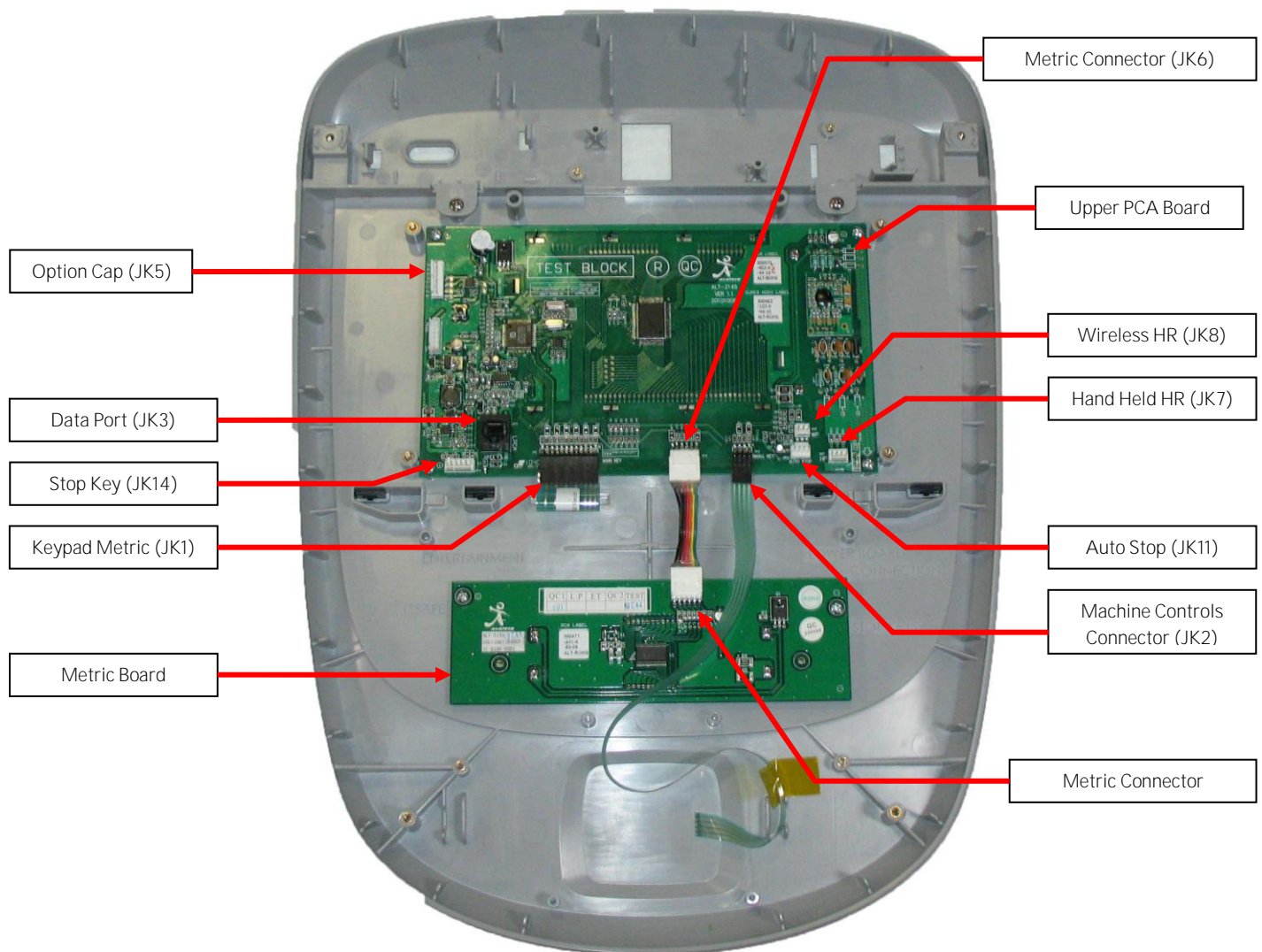

13. Install the replacement Metric PCA board into the console using the four screws removed in step 12. Torque to 10 inch pounds.

Note: Do not use an electric screw driver or over tighten the screws. Over tightening may damage the console. This type of damage is not covered under warranty.

14. The green wire in the Metrics cable indicate pin 1 and the symbol ( $\nabla$ ) indicates Pin 1 on the Metric board. Align the green wire with the pin 1 markings on the Metric board. See Diagram 6.6.9

Note: If pin 1 is not marked on the Metric boards refer to Diagram 6.6.9.

Diagram 6.6.9 – P20 PCA – Pin 1 Reference

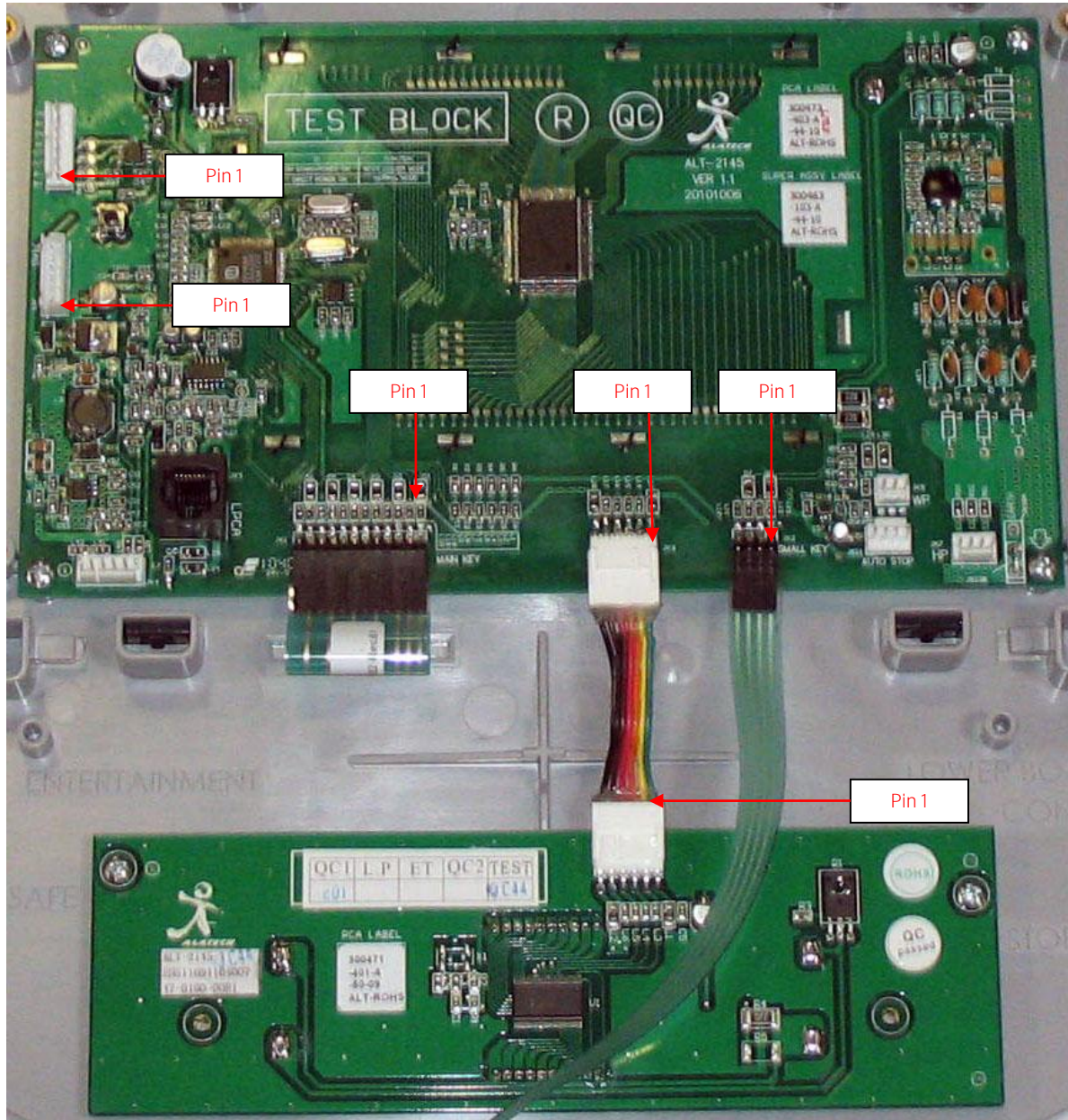

15. Connect the Metrics cable, to the Metric board.
16. Replace the P20 Rear Cover removed step 10 and secure the cover with the screws 6 screws. Torque to 10 inch pounds.  
 Note: Do not use an electric screw driver or over tighten the screws. Over tightening may damage the console. This type of damage is not covered under warranty.
17. Replace the P30 Option Cap back cover removed step 9 and secure the cover with the screws 2 screws. Torque to 10 inch pounds.

Note: Do not use an electric screw driver or over tighten the screws. Over tightening may damage the console. This type of damage is not covered under warranty.

18. Place the P20 console on the maintenance access hook.
19. Reconnect the Data cable, Auto Stop cable (Treadmill only), Stop Key cable (Treadmill only), Hand Held HR cable, Wireless HR cable, and the Earth Ground wire and to the Upper PCA. See Diagram 6.6.5.
20. Replace the access cover with the hardware removed in step 6.
21. Tilt the console back against the mounting plated. While tilting the console back feed the excess cable into weldment tube making sure that the cables will not become pinched.
22. Fasten the console to the dash mounting plate with the four screws removed in step 4. See Diagram 6.6.2.
23. Fasten the dash transition cover using the two screws removed in step 3. See Diagram 6.6.1
24. Check operation per Section Seven.

## Procedure 6.7 - P20 - Replacing Heart Rate PCA

1. Set the treadmill circuit breaker in the off position and unplug the treadmill's line cord from the AC outlet (Treadmill only).
2. Remove the console access panel per procedure 6.5.
3. The PCA's in the console are static sensitive. They can be damaged if proper static prevention equipment is not used. Attach an anti-static wrist strap to your arm, and then connect the ground lead of the wrist strap to the frame ground.
4. Disconnect the HR cable connector from the upper PCA.
5. Remove the HR PCA access panel on the back of the console. See Diagram 6.7.1
6. The HR PCA snaps into its mounting. Press its tabs downward and remove the HR PCA from its mounting.
7. Pull the HR PCA cable out of the console.
8. Route and the new HR cable through the console and reconnect it onto the upper PCA. See Diagram 6.7.2.
9. Snap the HR PCA into its mounting.
10. Replace the HR PCA access panel removed in step 5.
11. Replace the console access panel removed in step 2.
12. Check operation per Section 7.

Diagram 6.7.1



HR PCA Access Panel

Diagram 6.7.2

Wireless cable connection  
on the upper PCA

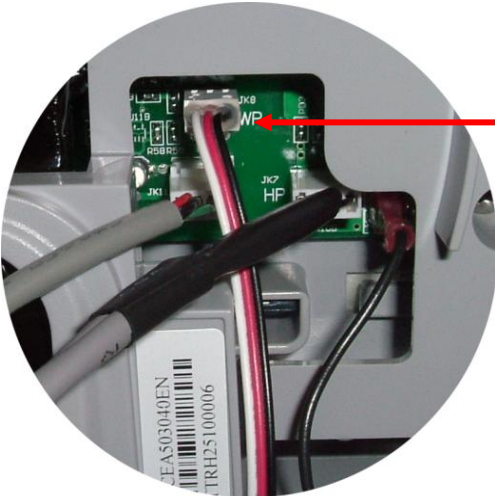

Procedure 6.8 – Future Content

Procedure 6.9 – Future Content

Procedure 6.10 – Future Content

## Troubleshooting 6.11 - P20 - Troubleshooting the Keypad and the Upper PCA

### Procedure

**Note:** The green wire on the cables shown in **Diagram 6.11.1** denotes pin 1. When these cables are inserted into their connectors, the green wire must align with the pin 1 designation on the PCA. If pin 1 is not marked on the PCA refer to **Diagram 6.11.1**.

1. Set the treadmill's on/off switch in the off position (Treadmill Only). Access the upper electronics and machine controls per Procedure 6.5, steps 1 through 11. Place the console on the maintenance mounting hook and reconnect all cables.
2. If the message STUCK KEY is when the unit is turned on for treadmill's or pedaling on the RBK, UBK, AMT, and EFX, skip to step 23.
3. If a key does not function, skip to step 18.
4. If the display does not illuminate, continue with step 5.

Diagram 6.11.1 - Console, Upper PCA , JTAG (J9), & Option Cap Connector

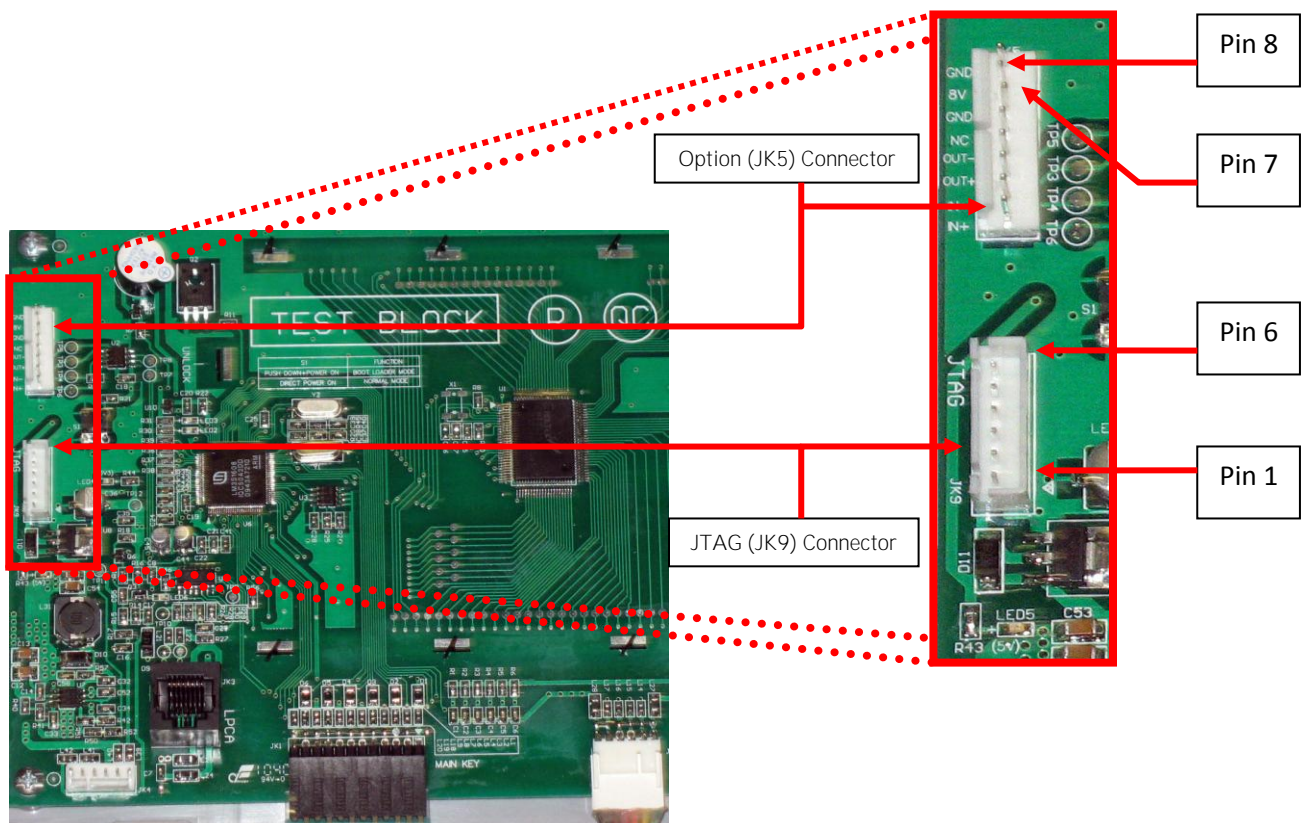



5. If the upper PCA is not illuminating, skip to step 12.
6. If the metrics PCA is not illuminating, continue with step 7.
7. Remove the four screws that fasten the metrics PCA to the display face and rotate it so that the front of the PCA is visible. For treadmill's set the on/off switch in the on position for AMT's, EFX's, UBK's, RBK's and CLM's start pedaling.
8. With a DC voltmeter, measure between C5 (+5V) and L2 (GND) on the metric board and L27 (+5V) and L28 (GND) of JK6 connector of the upper PCA for 5Vdc. See Diagram 6.11.3

Diagram 6.11.3 - Metrics PCA, Front View

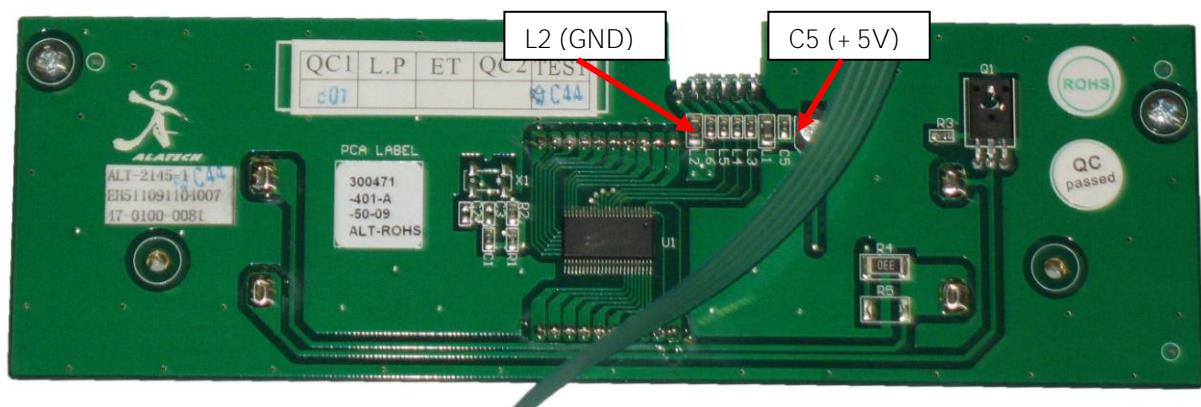

9. If 5 Vdc is not present on C5 and 5 Vdc is present on L27, replace the metrics cable between the upper PCA and the metrics PCA.
10. If 5 Vdc is present on C5 and the upper PCA is illuminating normally, replace the metrics PCA.
11. If you have performed steps 7 - 10 and the metrics PCA still does not illuminate, contact Precor customer support for assistance.
12. Set the treadmill's on/off switch in the on position. (Treadmill Only)
13. With a DC voltmeter, measure between pins 1 and 6 of JK9 (JTAG Connector) for 3.3 Vdc and between pins 6 and 7 of JK5 (Option Cap connector) for 8 Vdc.
14. If 3.3 Vdc is not present on JK9 and 8 Vdc is present on JK5, replace the upper PCA.
15. If 8 Vdc is not present on JK5, temporarily replace the upper PCA to power control module cable with a known good cable.
16. If the upper PCA illuminates normally, replace the upper PCA to power control module cable permanently. If the upper PCA still does not illuminate, replace the power control module (treadmills) or Lower PCA (AMT's, EFX's, UBK's, RBK's and CLM's).
17. If you have performed steps 12 - 16 and the upper PCA still does not illuminate, contact Precor customer support for assistance.

18. Set the treadmill's on/off switch in the on position. (Treadmill Only)
19. If none of the keys on the display are functioning, check the stop switch cable connection to the upper PCA (Treadmill's only). If the stop switch is not connected or the stop switch is not functioning, none of the display keys will operate. This feature insures that the treadmill has a functioning stop switch when it is in use (Treadmill's only).
20. If a particular key is not functioning, perform the keyboard test in **Procedure 6.2**. If the test verifies that the key is not functioning, replace the display face.
21. If the display face has been replaced and the same key or control is still not functioning, replace the upper PCA.
22. If you have performed steps 18 - 22 and the same key is still not functioning, contact Precor customer support for assistance.
23. Remove the keypad cable from the upper PCA. **See Diagram 6.5.8**.
24. For treadmill's set the on/off switch in the on position for AMT's, EFX's, UBK's, RBK's and CLM's start pedaling.
25. If the STUCK KEY message is no longer displayed, replace the display face. If the STUCK KEY message is still being displayed continue with step 26.
26. Set the treadmill's on/off switch in the off position. (Treadmill Only)
27. Remove the Machine Control cable from the upper PCA.
28. For treadmill's set the on/off switch in the on position for AMT's, EFX's, UBK's, RBK's and CLM's start pedaling.
29. If the STUCK KEY message is no longer displayed, replace the machine the display face.
30. If the STUCK KEY is still being displayed with the keyboard cable disconnected, replace the upper PCA.
31. If you have performed steps 23 - 30 and the STUCK KEY message is still being displayed, contact Precor customer support for assistance.

## Troubleshooting 6.12 - P20 - Troubleshooting Handheld Heart Rate

### Circuit Description

The hand held heart rate system is actually a dual system, that is, it can accept a heart rate signal from either the hand held heart rate contacts on the unit's handlebar or from a Polar heart rate chest strap transmitter. The heart rate circuit in upper PCA is configured for hand held priority. That is, if both a chest strap and hand heart rate signal are being received, the system will accept the hand held signal and ignore the chest strap signal. If a hand held signal is not being received, the system will accept the chest strap signal.

### Note:

There are four typical failure modes for the hand held/chest strap heart rate system. They are: hand held is normal - no chest strap reading; no hand held reading - chest strap normal; no hand held or chest strap reading or constant or intermittent readings when neither hand held or chest strap are in use.

Diagram 6.12.1 - Hand held/chest strap heart rate PCA

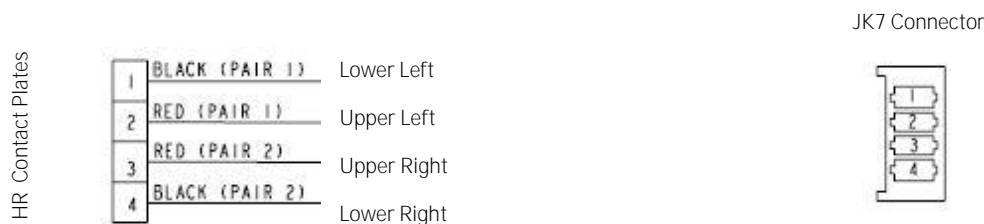

### Normal hand held reading - No chest strap reading

17. Access the diagnostic program (Procedure 6.1). Advance to the heart rate display portion of the diagnostic program. Verify that a chest strap signal is not being accepted with either a Polar heart rate test transmitter or a known good chest strap transmitter. If this reading is good, skip to step 3.
18. Using a known good Polar heart rate chest strap, verify that the heart rate operates with the known good chest strap. If the known good Polar chest strap does correct the problem, replace the original chest strap transmitter.
19. If the above procedures did not correct the problem, replace the wireless heart rate receiver.

## No hand held reading - Normal chest strap reading

20. Access the diagnostic program (Procedure 6.1). Advance to the heart rate display portion of the diagnostic program. Verify that a hand held signal is not being accepted by firmly grasping both the right and left hand held contacts on the handlebars. Cover as much of the top and bottom contact surface area with your hands as possible (without moving your hands), you should receive a heart rate reading within ten seconds.
21. If the hand held signal is now being accepted, something in the near vicinity is radiating RF (radio frequency) energy that is being received by the chest strap portion of the heart rate PCA. Discount the Wireless HR cable from the upper PCA.
22. If a hand held signal still not being accepted, skip to step 7.
23. Access the diagnostic program (Procedure 6.1). Advance to the heart rate display portion of the diagnostic program. Verify that a hand held signal is not being accepted by firmly grasping both the right and left hand held contacts with the opposite hands, right hand on the left handlebar contacts and left hand on the right handlebar contacts. Cover as much of the top and bottom contact surface area with your hands as possible, you should receive a heart rate reading within ten seconds. If a hand held signal is still not being accepted, skip to step 9.
24. If a hand held signal was accepted in step 11, the hand held contact wiring is reversed. The harness that connects to the hand held contacts in the handlebar is segregated into two groups. One group has blue shrink wrap around it and the other group has black shrink wrap around it. The blue group must go to the right hand contacts and the black group must go to the left hand contacts. If necessary, rewire the hand held contacts as described above and test as described in step 4.
25. If the wiring is correct, refer to Diagram 6.12.1 for the following measurements. With an ohmmeter measure between the lower right contact pin on the JK7 connector and the lower right hand held heart rate contact on the handlebar. The reading should be 1  $\Omega$  or less. Measure between the upper right contact pin on the JK7 connector and the upper right hand held heart rate contact on the handlebar. The reading should be 1  $\Omega$  or less. Measure between the upper left contact pin on the JK7 connector and the upper left hand held heart rate contact on the handlebar. The reading should be 1  $\Omega$  or less. Measure between the lower left contact pin on the JK7 connector and the lower left hand held heart rate contact on the handlebar. The reading should be 1  $\Omega$  or less. If any of the above readings are greater than 1  $\Omega$ , replace the heart rate PCA to handlebar wire harness.

No hand held reading - No chest strap reading

26. Access the diagnostic program (Procedure 6.1). Advance to the heart rate display portion of the diagnostic program. Verify that neither a chest strap signal or a hand held signal is being accepted with either a heart rate test transmitter or a chest strap transmitter.
27. Check the plug/connector connections on both the hand held heart rate (JK7) and wireless heart rate (JK8) at the upper PCA.
28. If neither a chest strap signal or a hand held signal is being accepted, measure between the replace the upper PCA.

## Section Seven – Checking AMT Operation

This section provides you with a quick method of checking AMT operation. Check the operation of the AMT at the end of most maintenance procedures.

### Procedure

1. Start striding on the AMT or plug the optional external power supply (when available) into the AMT and the AC outlet.
2. When the PRECOR banner displayed, press QUICK START.
3. Select Resistance Level 1 and press ENTER.
4. Operate the AMT for 4-5 minutes. As you operate the AMT, concentrate on the operating sounds made by the unit. Be on the alert for unusual rubbing, hitting, grinding, or squeaking noises.
5. Ensure that the AMT is properly leveled, that all five feet are in contact with the floor and there is no side to side rocking.
6. If the AMT makes unusual noises or the electronic display does not change appropriately, troubleshoot per Section 6.
7. Press the RESISTANCE ▲ key until you reach Resistance Level 10. Operate the AMT for another 2-3 minutes.
8. If the AMT resistance does not change or the operation of the AMT feels inconsistent compared with Resistance Level 1, troubleshoot per Section 6.
9. Press the RESISTANCE ▲ key until you reach Resistance Level 20. Operate the AMT for another 2-3 minutes.
10. If the resistance of the AMT does not change or the AMT operation feels inconsistent with Resistance Levels 1 and 10, troubleshoot per Procedure 6.4.
11. Check the LED's mounted on the upper PCA and the function keys displayed on the electronic console by performing Procedure 3.2.
12. Check stride indicator for proper operation.
13. Check wireless and hand held heart rate functions.

## Section Eight - Inspection and Adjustment Procedures

### Procedure 8.1 - Preventive Maintenance

Preventive maintenance measures are either scheduled or unscheduled. Scheduled preventive maintenance activities are included here so that you are aware of preventive measures performed on a regular basis.

#### Regular Preventive Maintenance (Owner)

Cleanliness of the AMT and its operating environment will keep maintenance problems and service calls to a minimum. Precor recommends that you perform the following preventive maintenance schedule.

#### After Each Use

- Wipe down the covers, handlebars and stairarms with a damp cloth.

#### Daily Maintenance

Clean the AMT's frame, covers, stairarms and foot pedals using water or a 30:1 solution of Simple Green® and water. Wipe the surface of the electronic console with a damp sponge or soft cloth. Dry with a clean towel. A 30:1 solution of Simple Green® and water or Contec Athletix® wipes are the only cleaning products that have been tested and approved for use on the AMT. The use of an acid (citric) based cleaner is not authorized by Precor.

#### Weekly Maintenance

- Vacuum underneath the AMT, following these steps:
  1. Unplug the optional external power supply (when equipped) from the AC outlet
  2. Remove the platform at the rear of the AMT.
  3. Carefully lift the rear of the AMT and move it to a temporary location.
  4. Vacuum the rug or damp mop the floor.
  5. Make sure that the floor is dry before returning the AMT to its original position and replacing the platform.
- Re-level the AMT to ensure that all five feet are in contact with the floor.
- Thoroughly test all AMT per Section Four, including heart rate.
- Cardio Theater cord management must be observed.

## Quarterly Maintenance

1. Remove the side covers per Procedure 10.11.
2. Check the belt alignment and tension as in Procedure 8.4.
3. Clean the inside of the AMT.
4. Inspect fasteners for proper tightness and torque.
5. Check for excessive noise during vertical and horizontal operation.
6. Replace the side covers.
7. Re-level the AMT to ensure that all five feet are in contact with the floor.

## On-Site Preventive Maintenance (Service Technician)

- When you are called to service a AMT, perform these preventive maintenance activities:
- Perform the software diagnostics. Check LED and keypad function. Record the odometer reading.
- Check stride rate and stride length sensor function (is the stride rate and stride length displayed when the unit is in operation?).
- Visually inspect the drive belts for cracks, fraying or excessive wear.
- When furnished, inspect the optional power supply cords. If a power supply cord(s) is damaged, install a new power supply.
- Visually examine all wires and check connectors and wire connections. Secure connections and replace wiring as necessary.
- Cardio Theater cord management must be observed.



## Procedure 8.2 - Measuring the Resistance of a Generator

### Caution

If an external power supply is connected to the AMT, disconnect the external power supply from the AMT before continuing with this procedure.

### Procedure

1. Remove the right side cover per Procedure 10.11.
2. Remove the red battery wire from the lower PCA. See Diagram 8.2.1.

### WARNING

Before continuing with this procedure, review the Warning and Caution statements listed in Section One, Things You Should Know.

3. Set the ohmmeter to a range that will conveniently read up to 50 W.
4. Remove the two wires from the **LOAD** terminals of the lower PCA.
5. With an ohmmeter, read between the wires removed in step 5. The reading should be approximately 10W. Replace the two wires removed in step 5.
6. Remove the three wires from the **3 PHASE GEN IN** terminals of the lower PCA.
7. With an ohmmeter, read between the red & white, red & black and white & black wires. Each reading should be approximately 25W. Reconnect the wires removed in step 7.
8. If any of the readings are significantly high or significantly low, remove the intermediate cable from the generator and perform the same measurements as in step 4 on the generator connector. If the reading is now correct check and or replace the intermediate cable. Refer to Diagram 8.2.1. If the readings are still incorrect, remove the three phase generator.
9. Reconnect the red battery wire removed in step 3.
10. Replace the right side cover.

## Procedure 8.3 - Inspecting and Adjusting Belt Tension

### WARNING

Before continuing with this procedure, review the Warning and Caution statements listed in Section One, Things You Should Know.

### Procedure

#### Primary Belt Adjustment

1. Remove the front, rear, left and right side covers per Procedure 10.11.
2. Place a belt gauge to the primary belt as shown in Diagram 8.3.1.

#### Diagram 8.3.1 - Primary Belt Tension Adjustment

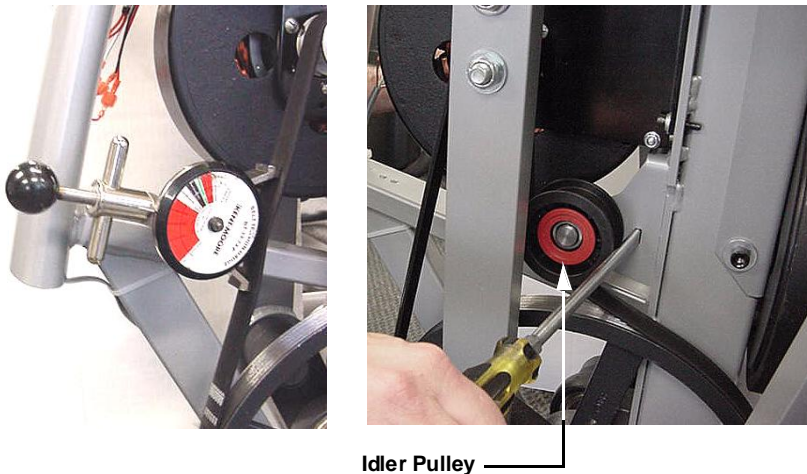

3. The belt gauge should read approximately 70 lbs. If the belt tension is significantly high or low the belt tension may be adjusted by loosening the idler pulley mounting bolt and carefully prying against the idler pulley to obtain the correct belt tension. When belt the tension is correct, torque the idler pulley mounting bolt to 17 - 21 foot pounds (200 - 250 inch pounds).

## Brake Belt Adjustment

4. Check the tension of the brake belt using the belt gauge, shown in Diagram 8.3.2. Belt tension should be 110 lbs  $\pm$  10 lbs.
5. If the belt tension is incorrect, adjust the belt tension using the adjustment bolt shown in Diagram 5.3.

Diagram 8.3.2 - Brake Belt Idler Pulley Mounting Bolt

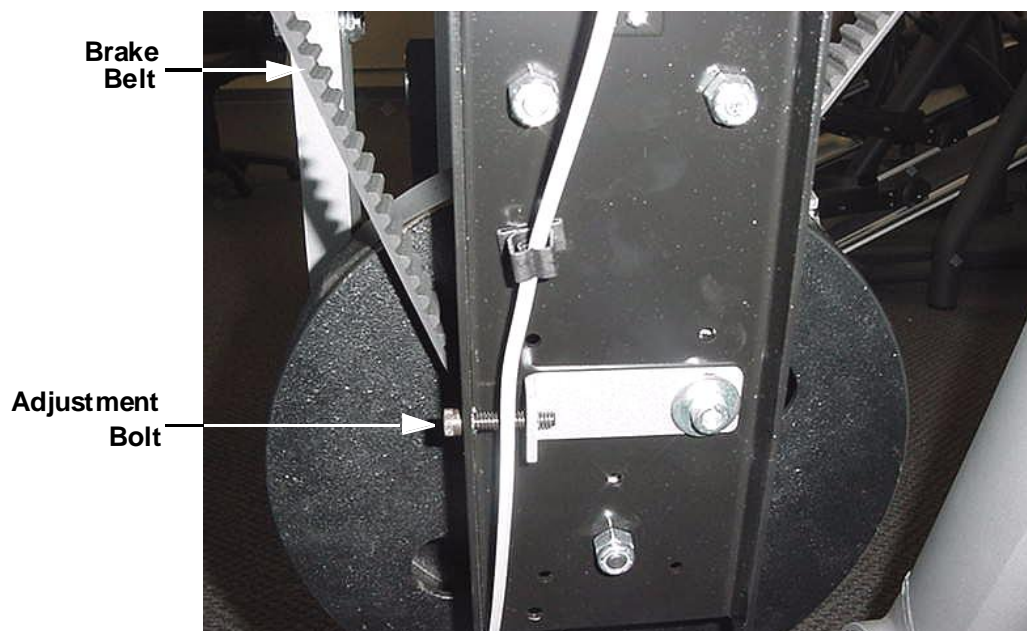

## Procedure 8.4 - Drive Belt Alignment

The alignment of the drive belt between the generator pulley and the primary pulley is important. Incorrect alignment will cause premature belt wear and/or belt noise.

1. Remove front, rear, left and right side covers per Procedure 7.11.
2. Loosen but do not remove the four pillow block mounting bolts. See Diagram 8.4.1.

Diagram 8.4.1 - Drive Belt Alignment

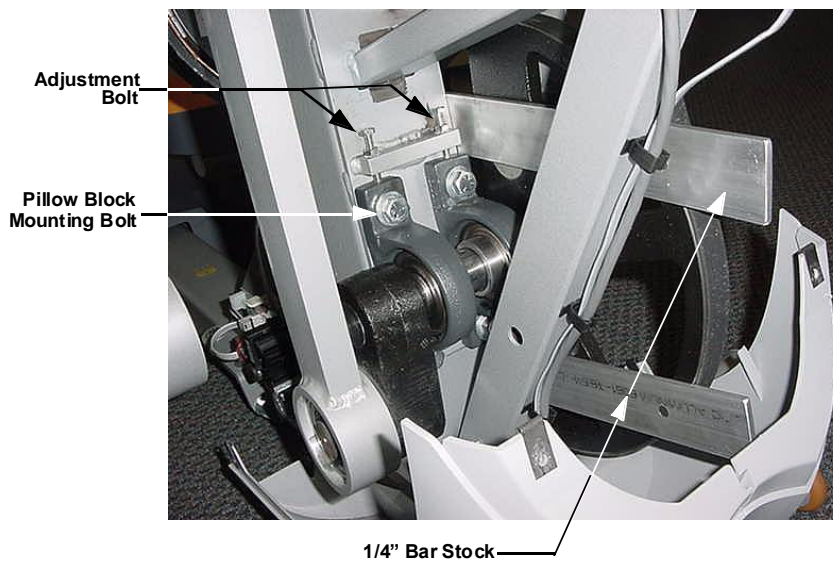

3. Slide two pieces of 1/4 inch thick bar stock between the upper and lower portions primary pulley and the frame as shown Diagram 5.4.
4. Use the two adjustment bolts, shown in Diagram 8.4.1, to align the primary pulley square to frame and a 1/4 from the frame.
5. Torque the four pillow block mounting bolts to 60 - 65 foot pounds (720 - 780 inch pounds).
6. Test the alignment of the drive belt by pedaling the unit in both the forward and reverse directions. The drive belt must remain squarely on the pulley face, not riding off the edge of the pulley, with no belt noise being generated.
7. Replace the covers removed in step 1.

## Section Nine - AMT Troubleshooting Procedures

### Troubleshooting 9.1 - Troubleshooting Interconnect Cable

1. Remove the display's rear cover.
2. Remove the right side cover.
3. Disconnect the interconnect cable from the upper PCA and the lower PCA.
4. External of the upper column, connect a replacement interconnect cable to the lower PCA and the upper PCA.
5. Check operation as described in Section Seven. If the unit works properly, replace the interconnect cable as described in Procedure 10.2.
6. If you have performed all of the procedures above and have been unable to correct the problem, call Precor customer support.

## Troubleshooting 9.2 - Troubleshooting the Generator

The generator performs three functions in the AMT. First, by controlling the amount of electrical load applied to the generator, the user's pedaling resistance is controlled. Second, the generator is used to charge the AMT's internal battery. Lastly, one of the generator's six phase output windings is monitored to determine when the unit is in use and when it is idle. This system also determines the stride rate by determining the operating speed (output frequency) of the monitored generator winding.

### Warning

Because this is a self-powered unit, it will either be necessary to either equip the unit with the optional external power supply or have an assistant pedal on the unit while voltage measurements are being taken. Because of the danger of working on the unit while it is in motion using the optional external power supply is strongly recommended.

1. Perform the generator resistance test per Procedure 8.2. If any of the resistance measurements are significantly high or significantly low, replace the generator.
2. The following voltage reading must be taken while the unit is in motion. Extreme care must be taken to keep meter wires, hands, etc. clear of all moving parts. Using an AC voltmeter, measure the voltage between red and black, red and white and black and white wires at **3** Phase Gen In of the lower PCA. AC voltage readings will vary depending on the unit's stride rate at the time the measurement is taken. At a stride rate of 50 strides per minute, all three voltage readings will be approximately 40 VAC - 45 VAC.
3. If any of the readings in step 2 are significantly low, replace the generator. If you have performed all of the above tests and are unable to resolve the problem, contact Precor customer support.

## Section Ten - AMT Replacement Procedures

### Procedure 10.1 - Replacing the Lower PCA

1. Remove the right side cover.

#### WARNING

Before continuing with this procedure, review the Warning and Caution statements listed in Section One, Things You Should Know.

2. Attach the wrist strap to your arm, and then connect the ground wire of the wrist strap to the AMT frame.
3. Disconnect the battery, 3 Phase Gen and load wires from the lower PCA.
4. Remove the screw from the upper right corner the lower PCA, see Diagram 10.1.1.

Diagram 10.1.1 - Lower PCA

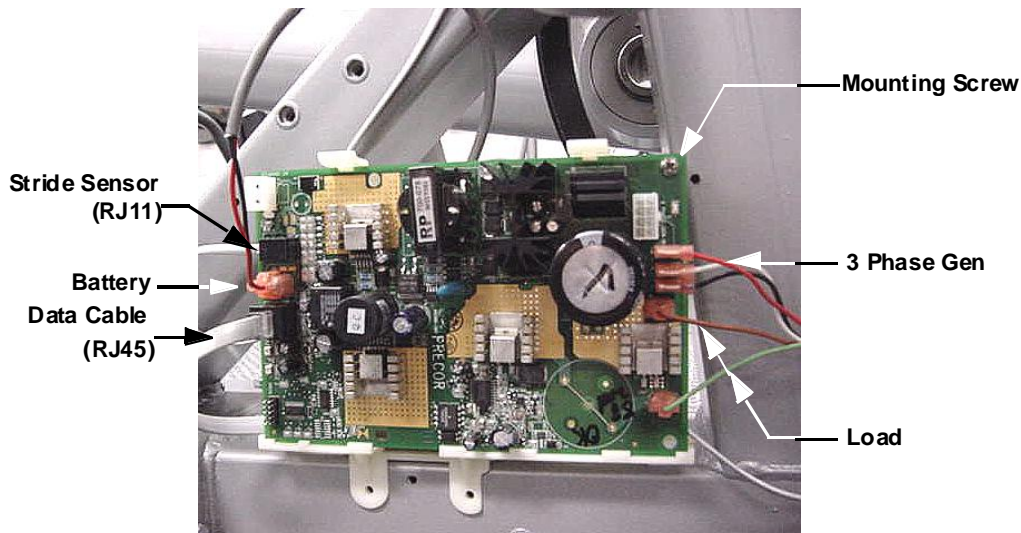

5. Unsnap the lower PCA from its mounting bracket.
6. Position the replacement lower PCA at its mounting position and snap it into its mounting bracket. Fasten it with the screw removed in step 4.
7. Reconnect the lower PCA wires as follows. The battery wires are polarized to prevent them from being connected incorrectly. Connect the black wire to the battery terminal nearest to the edge of the lower PCA and the red wire to the remaining battery terminal of the lower PCA. Reconnect the 3 Phase Gen wires to the terminals shown in Diagram 10.1.1, the wires may be connected in any order. Reconnect the load wires to the terminals shown in Diagram 10.1.1, the wires may be connected in any order.
8. Remove the ground wire of the wrist strap from the AMT frame, and then remove the wrist strap from your arm.
9. Re-install the right side cover, and then check the operation of the AMT as described in Section Seven.

## Procedure 10.2 - Replacing the Interconnect Cable

Before you install a new interconnect cable, ensure that the interconnect cable is defective as described in Procedure 9.1.

### WARNING

Before continuing with this procedure, review the Warning and Caution statements listed in Section One, Things You Should Know.

1. Remove the four screws from the display rear cover and remove the display rear cover.
2. Disconnect the interconnect cable from the upper PCA. See Diagram 10.2.1.
- 3.

Diagram 10.2.1 - Display, Rear View

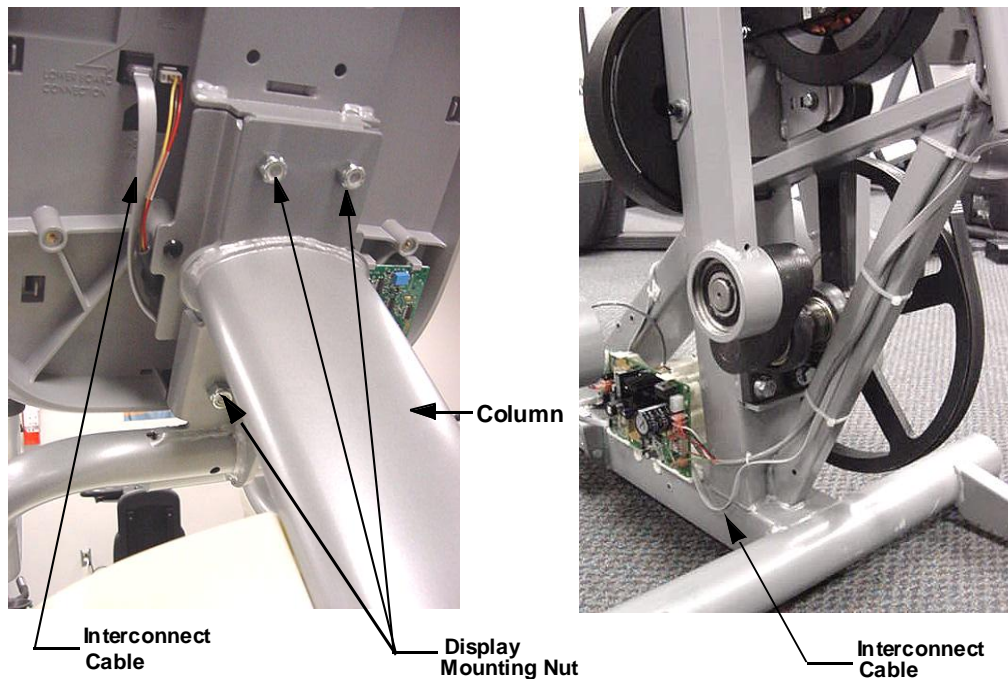

4. Remove the four nuts that fastens the display to the column. Remove the display and set it aside. See Diagram 10.2.1.
5. Remove the right side cover.
6. Carefully, cut and remove the tie wraps that fasten the interconnect cable to the frame.
7. Disconnect the interconnect cable from the lower PCA.
8. Remove the interconnect cable from the column.
9. Slide the replacement interconnect cable down the column so that approximately 6 inches of remains at the top of the column.
10. Set the display at its mounting position and fasten it with the four nuts removed in step 3.
11. Connect the interconnect cable to the upper PCA and to the lower PCA as shown in Diagram 10.2.1.
12. Dress the interconnect cable along the frame as shown in Diagram 10.2.1 and secure it with four tie wraps.
13. Replace the display rear cover and the right side cover.
14. Check the operation of the AMT as described in Section Seven.



## Procedure 10.3 - Replacing Primary Belt

### WARNING

Before continuing with this procedure, review the Warning and Caution statements listed in Section One, Things You Should Know.

1. Remove the left side cover.
2. Remove the bolt that fastens the left side upper arm weldment. Remove the handlebar from its mount and lower the assembly to the floor. See Diagram 10.5.1.
3. Loosen, but do not remove the bolt that fastens the idler pulley and remove tension from the primary belt. See Diagram 10.3.1.

Diagram 10.3.1 - Primary Belt

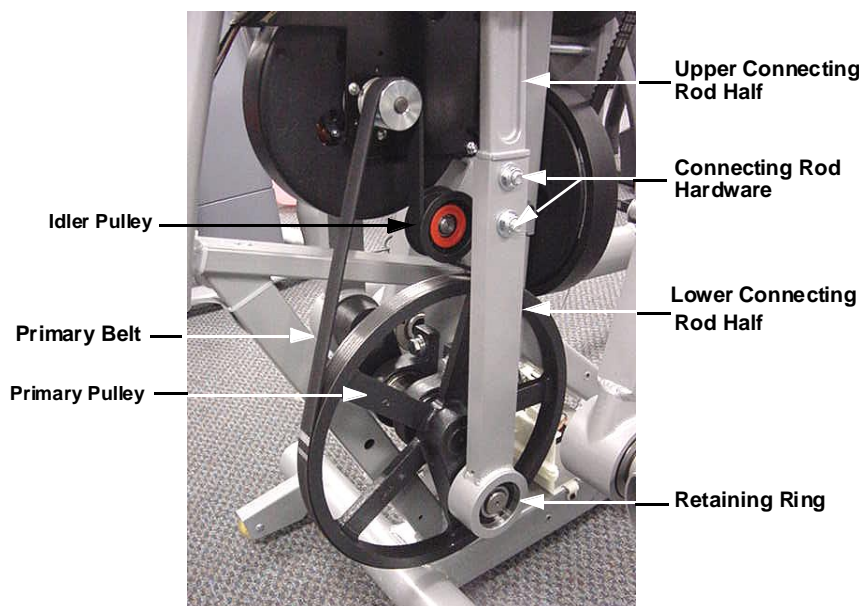

4. Remove the hardware that fastens the upper and lower connecting rod halves together. Separate the lower connecting rod half from the upper connecting rod half. See Diagram 10.3.1.
5. Remove and discard the primary belt.
6. Set the replacement primary belt in its mounting position with it routed around the front of the idler pulley.
7. Tension the primary belt per Procedure 8.3.
8. Slide the upper connecting rod half into the lower connecting rod half and fasten them with the hardware removed in step 4. Torque the connecting rod bolts to 17 - 21 foot pounds (200 - 250 inch pounds).
9. Raise and insert the left side handlebar on its mount and fasten it with the hardware removed in step 2.
10. Replace the left side cover.

## Procedure 10.4 - Replacing Brake Belt

### WARNING

Before continuing with this procedure, review the Warning and Caution statements listed in Section One, Things You Should Know.

1. Remove the rear covers, and the left and right side covers.
2. Remove the hardware that fastens the connecting rods to the brake sheave and remove the connecting rods from the brake assembly.
3. Disconnect the speed sensor cable from the speed sensor PCA.
4. Loosen but do not remove the two bottom brake assembly mounting bolts. Remove the two upper brake assembly mounting bolts. Carefully remove the brake assembly and place it on a flat solid work surface.
5. Loosen the belt tension adjustment bolt. Remove the idler pulley mounting bolt and the idler pulley. See Diagram 10.4.1.
6. Remove the hardware that fasten the two spacers in the center of the brake assembly, remove the spacers.

Diagram 10.4.1 - Brake Assembly

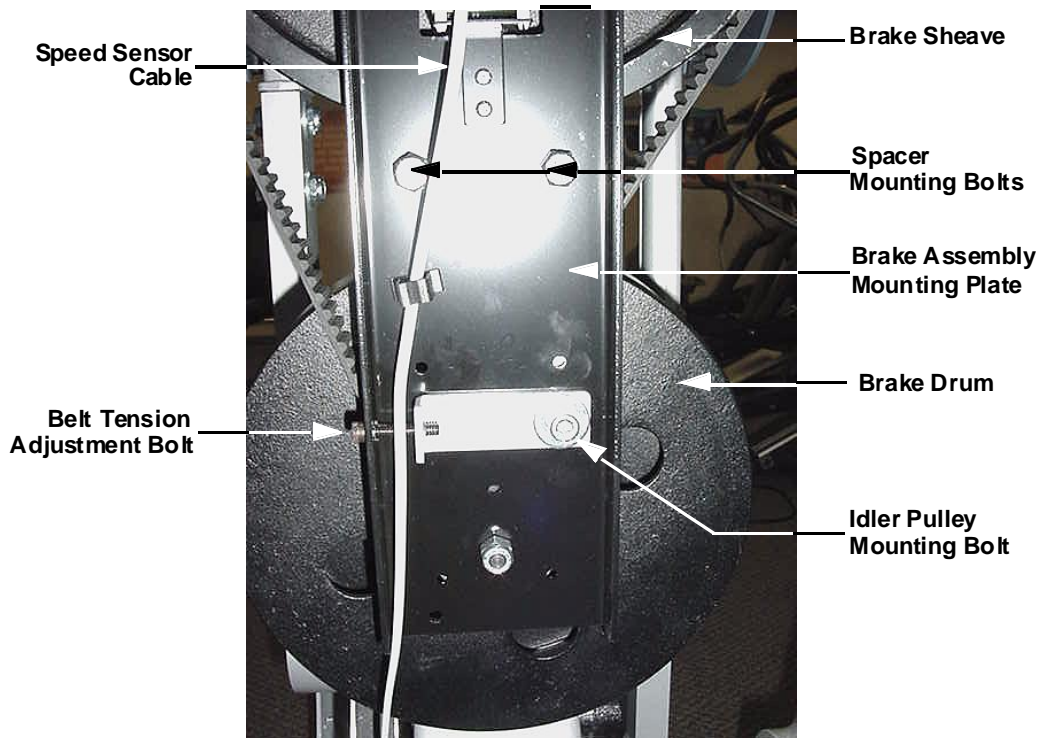

7. Remove the four screws from the belt bracket and remove the belt bracket. Remove the brake belt by lifting it over the top and bottom edges of the brake assembly mounting bracket.
8. Set the replacement belt on the brake assembly, with the four holes in the belt aligned with the four holes in the brake sheave, by lifting the belt over the bottom and top edges of the brake assembly mounting plate. Replace the belt attachment bracket and fasten it with the four screws removed in step 7.

9. Replace the two spacers and fasten them with the hardware removed in step 6.
10. Replace the idler pulley, with the belt on the left side of the idler pulley and fasten it with the hardware removed in step 5.
11. Carefully set brake assembly its two lower mounting bolts, left in the frame in step 4, and hand start the upper brake assembly mounting bolts. Torque the four brake assembly mounting to 17 - 21 foot pounds (200 - 250 inch pounds).
12. Reconnect the speed sensor cable to the speed sensor PCA. Dress the speed sensor cable into its cable clip.
13. Rotate the brake sheave into position, with the brake attachment bracket on top. Insert the connecting rods into brake sheave and fasten them with the hardware removed in step 2. Torque the connecting rod bolts to 100 - 110 inch pounds.
14. Tension the brake belt per Procedure 8.3.
15. Replace the left and right side covers, and then replace the rear covers.

## Procedure 10.5 - Replacing the Primary Pulley Assembly

### WARNING

Before continuing with this procedure, review the Warning and Caution statements listed in Section One, Things You Should Know.

1. Remove the left and right side covers and the front cover.
2. This step removes most of the weight from the primary pulley connecting rods and makes the subsequent steps in this procedure easier and safer. Remove the bolt that fastens one of the upper arm weldments. Remove the upper arm weldment from its mounting and lower the assembly to the floor. Repeat this procedure with the remaining upper arm weldment. See Diagram 10.5.1.

Diagram 10.5.1 - Stairarm Rear Link Assemblies

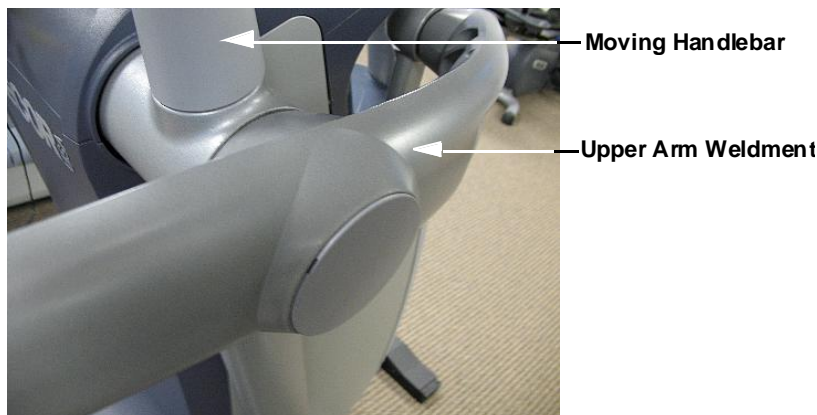

3. Loosen, but do not remove the idler pulley mounting bolt. See Diagram 10.3.1.
4. Remove the retaining clip from the lower end of the lower connecting rod half. See Diagram 10.3.1.
5. Remove the hardware that fastens the upper connecting rod half to the lower connecting rod half.
6. Separate the upper and lower connecting rod halves and remove the lower connecting rod half from the primary pulley.
7. Repeat steps 4 to 6 on the remaining connecting rod.
8. Remove the primary belt.
9. Remove the four bolts that fasten the primary pulley assembly to the frame. Remove the primary pulley assembly.
10. Set the replacement primary pulley assembly in its mounting position and fasten it with the hardware removed in step 9.
11. Set the primary belt in its mounting location with the belt routed in front of the idler pulley.
12. Tension the primary belt per Procedure 8.3.
13. Slide one of the tie lower connecting rod halves onto the primary pulley and fasten it with the retaining clip removed in step 4.

14. Slide the upper connecting rod half into the lower connecting rod half and fasten it with the hardware removed in step 5.
15. Repeat steps 13 and 14 with the remaining connecting rod halves.
16. Raise one of the upper arm weldments and attach it to the upper arm casting and fasten it with the bolt removed in step 2. Repeat this procedure with the remaining upper arm weldment.
17. Replace the front cover. Replace the left and right side covers.

## Procedure 10.6 - Replacing a Generator

### WARNING

When the unit is used, stairarms are in motion or the generator is rotated by any means, the generator will produce potentially hazardous voltages even when the battery is disconnected.

1. Remove the left and right side covers. Remove the front cover.
2. Loosen but do not remove the primary belt idler pulley mounting bolt. See Diagram 10.3.1.
3. Remove the primary belt from the generators pulley.
4. Disconnect the generator wires at the midpoint connection. See Diagram 10.6.1.

Diagram 10.6.1 - Generator Mounting

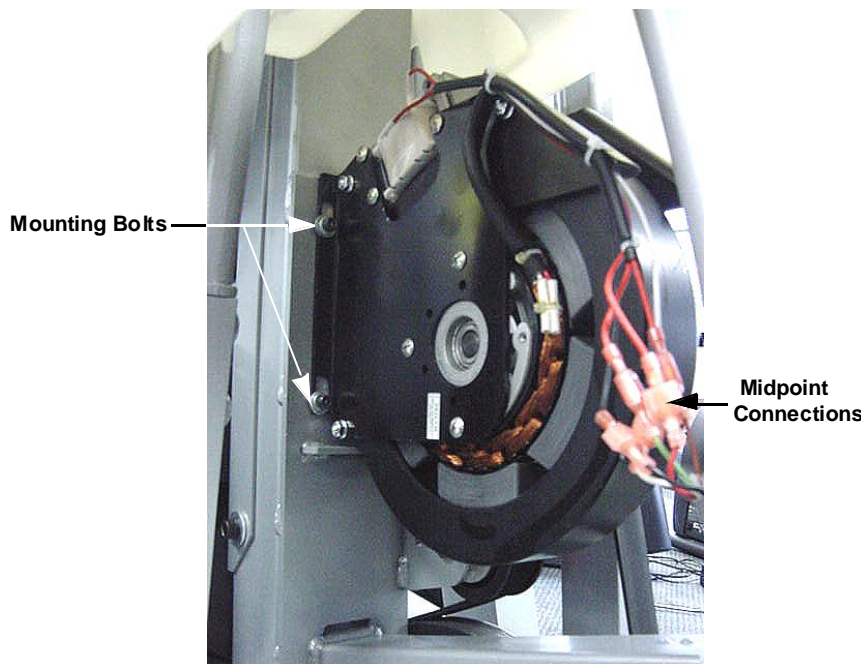

5. Remove the four generator mounting bolts and remove the generator.
6. Set the replacement generator in its mounting position and fasten it with the hardware removed in step 5. Torque the generator mounting bolts to 100-110 inch pounds.
7. Place the primary belt on the generators pulley and tension the belt per Procedure 8.3.
8. Reconnect the generator midpoint connections as follows. Connect the two red wires from the generators eddy current magnet to the green and brown wires in the midpoint cable, the order does not matter. Connect the red, white and black wires from the generator to the red, white and black wires in the midpoint cable.
9. Replace the front cover. Replace the left and right side covers.

## Procedure 10.7 - Replacing a Battery

1. Remove the left side cover.
2. Disconnect the red and black wires from the battery.
3. Gently expand the plastic battery bracket and slide the battery out of the bracket.
4. Slide the replacement battery into the plastic battery bracket so that the positive terminal (red dot) is on the right side and the negative terminal is on the left side.
5. Connect the red wire removed in step 2 to the positive terminal (red dot) of the battery and the black wire removed in step 2 to the negative terminal of the battery.
6. Replace the left side cover.
7. Test the AMT per Procedure Seven.

## Procedure 10.8 - Replacing a Stairarm

1. Use a flat bladed screwdriver to depress the tab in the lower cover and slide the lower cover up on the rear link. See Diagram 10.12.2.
2. Remove the two bolts that fasten the stairarm to the rear link assembly. Lower the stairarm to the floor. See Diagram 10.8.1.

Diagram 10.8.1 - Stairarm and Rear Link Assembly

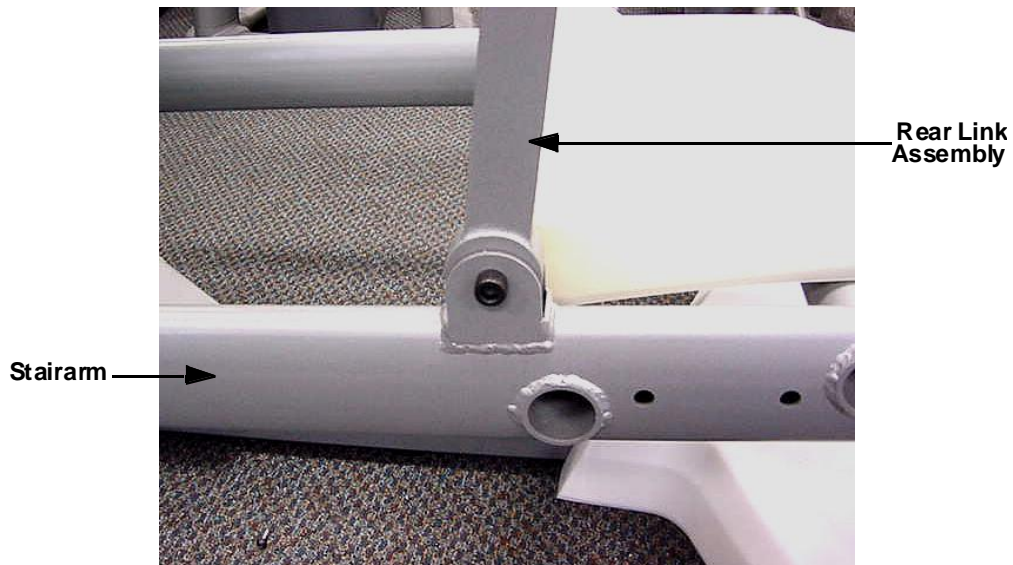

3. Remove the retaining clip and large washer that fastens the front of the stairarm to the front arm assembly. See Diagram 10.8.2.

Diagram 10.8.2 - Stairarm and Front Arm Assembly

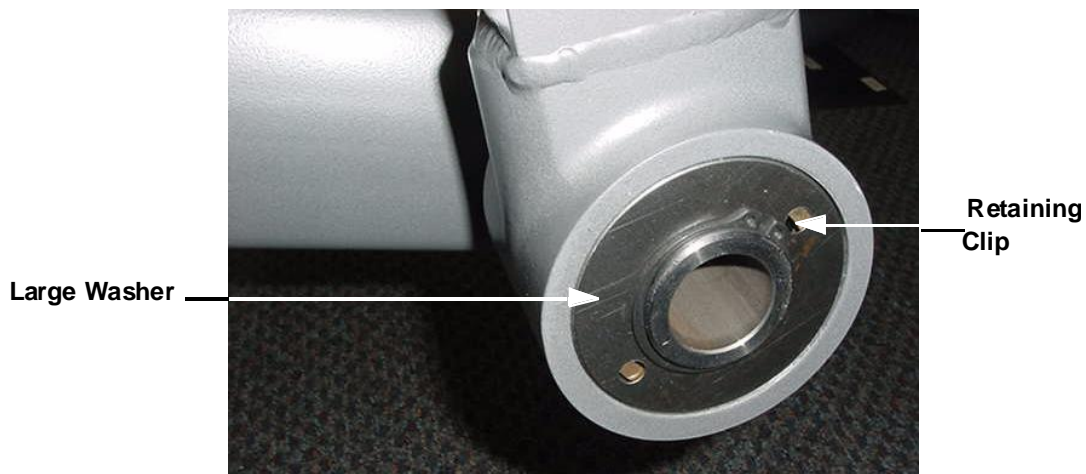



4. Remove the stairarm from the front arm assembly.
5. Remove the two screws that fasten the foot pedal to the stairarm and remove the foot pedal.
6. There are two bearings in the front arm assembly. The inner race of the bearings is not attached to the bearings and will come loose when the stairarm is removed. See Diagram 10.8.3.

Diagram 10.8.3 - Front Brace Bearings

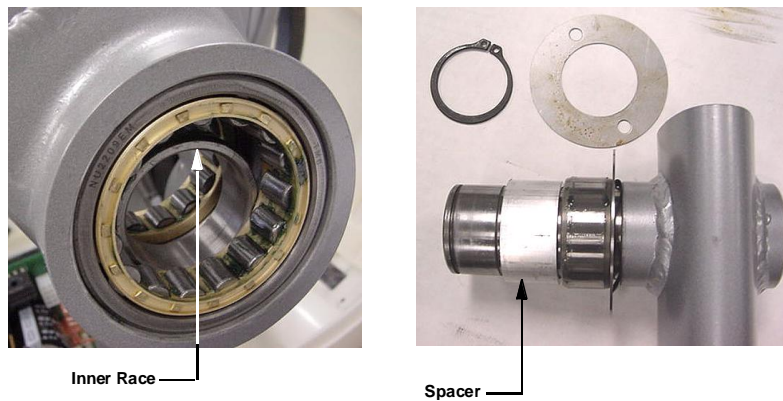

7. Left hand view of Diagram 10.8.3 shows that the inner race of the far bearing has fallen into the space between the bearings. This race must be slid back into the far bearing. The right hand view of Diagram 10.8.3 shows that the inner race of the near bearing has stayed on the stairarm. This arrangement is typically what happens when the stairarm is removed.
8. Remove the spacer, the inner race, two large washers and a wave washer from the stairarm. The clearance between the stairarm shaft and the inner race is very small. It is very easy to jam the inner race on the stairarm shaft.
9. Slide the wave washer and two large washers on to the stairarm shaft. Carefully, slide the inner race all of the way onto the shaft and against the large washers. Slide the spacer onto the shaft of the stairarm. The arrangement should be as shown in Diagram 10.8.3, above.
10. Slide the inner race that is in the front arm assembly into the far bearing.
11. Carefully, slide the stairarm into the front arm assembly. The inner race of the far bearing will probably slide part way out of the bearing. Using a small blunt tool, gently tap the race back into the bearing.
12. Set the foot pedal in its mounting position and fasten it with the hardware removed in step 4.
13. Lift the stairarm and fasten it to the rear link assembly with the hardware removed in step 1. Torque the rear links assembly hardware to 100 - 110 inch pounds.

## Procedure 10.9 - H-Brake Removal and Replacement

1. Remove the lower rear cover, the left and right lower rear side covers, upper rear cover, left side cover and right side cover per Procedure 10.9.1.
2. Remove the nuts and bolts that retain both tie rods to the H-brake assembly. See Diagram 10.9.1

Diagram 10.9.2 - H-Brake Tie Rod Mounting

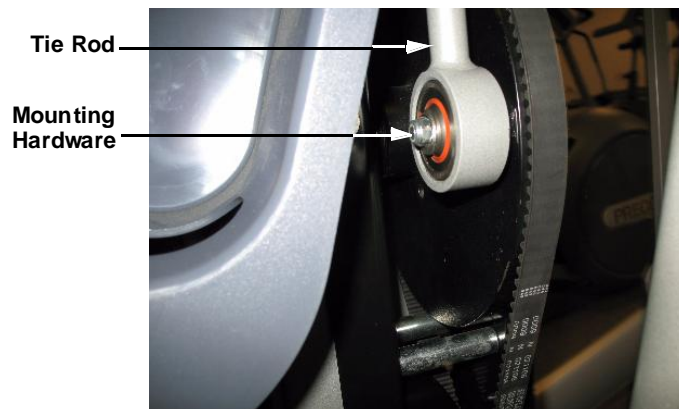

3. Disconnect the sensor cable from the H-brake assembly. Remove the cable from the cable clamp on the H-brake assembly. See Diagram 10.9.2.

Diagram 10.9.2 - H-Brake Sensor Cable

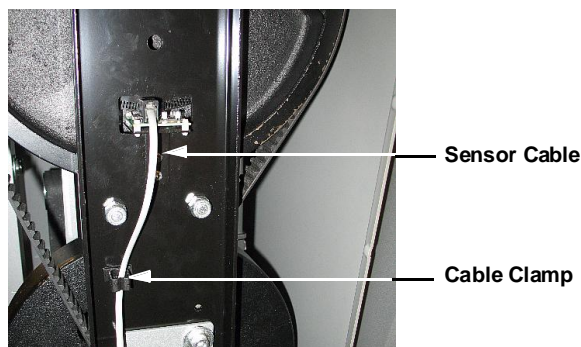

4. While supporting the H-brake assembly, it is heavy and you may wish to have an assistant support it, remove the four H-brake mounting bolts and remove the H- brake assembly from the AMT. See Diagram 10.9.3.



## Procedure 10.10 - H-Brake Removal and Replacement

1. Remove the lower rear cover, the left and right lower rear side covers, upper rear cover, left side cover and right side cover per Procedure 10.10.1.
2. Remove the nuts and bolts that retain both tie rods to the H-brake assembly. See Diagram 10.10.1

Diagram 10.10.1 - H-Brake Tie Rod Mounting

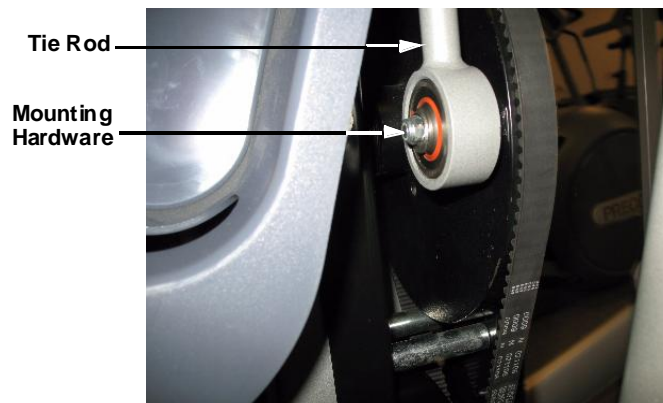

3. Disconnect the sensor cable from the H-brake assembly. Remove the cable from the cable clamp on the H-brake assembly. See Diagram 10.10.2.

Diagram 10.10.2 - H-Brake Sensor Cable

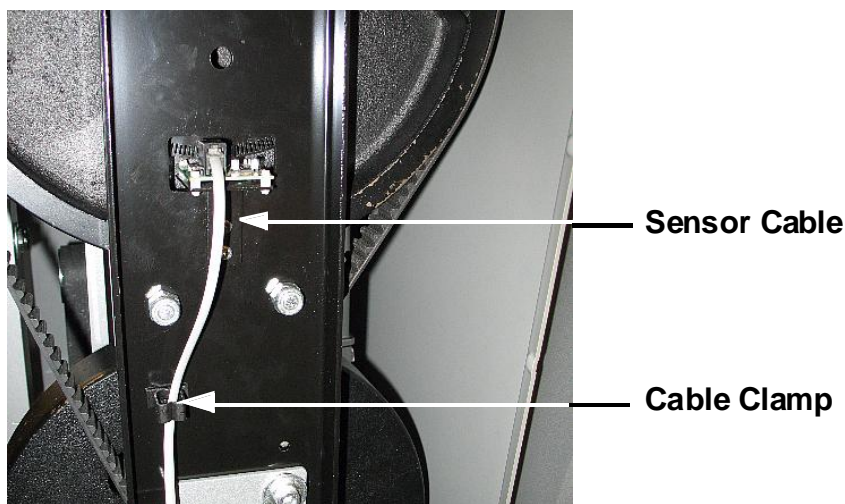

4. While supporting the H-brake assembly, it is heavy and you may wish to have an assistant support it, remove the four H-brake mounting bolts and remove the H- brake assembly from the AMT. See Diagram 10.10.3.

Diagram 10.10.3 - H-Brake Mounting Bolts

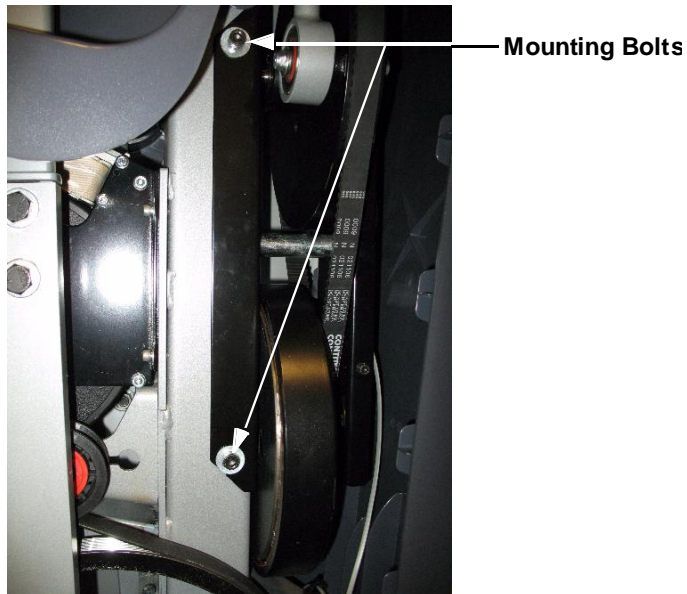

5. Set the replacement H-brake in its mounting position, If possible have an assistant support the H-brake, and replace the four H-brake mounting bolts removed in step 4. Torque the H-brake mounting bolts to 200-250 inch pounds (17 - 21 foot pounds).
6. Reconnect the sensor cable, disconnected in step 3 and route it through its cable clamp.
7. Fasten the tie rods to the H-brake assembly with the hardware removed in step 2. Torque the tie rod hardware to 100 - 110 inch pounds (8 - 9 foot pounds).
8. Replace the lower rear cover, the left and right lower rear side covers, upper rear cover, left side cover and right side cover per Procedure 10.11.

## Procedure 10.11 - Replacing a Cover

### Cover Removal

1. Using a flat bladed screwdriver, carefully pry both sides of the lower rear cover loose from its mounting. See Diagram 10.11.1. Remove the lower rear cover.

Diagram 10.11.1 - Lower Rear Cover

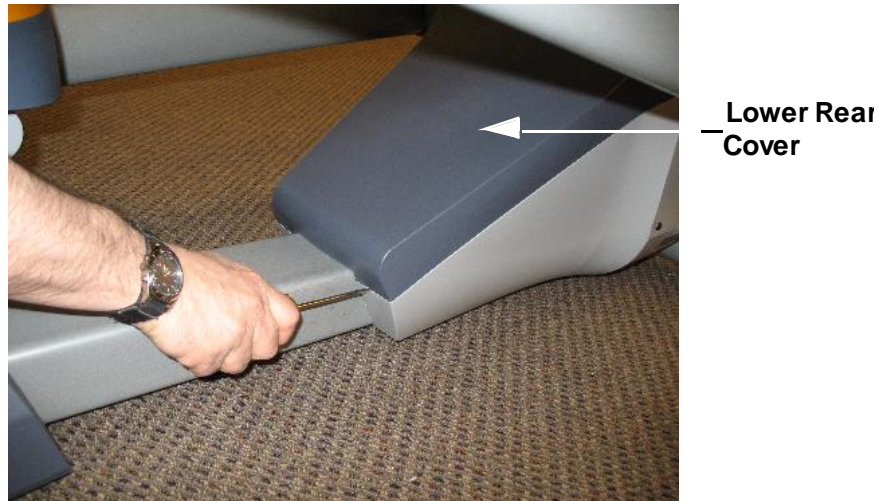

2. Remove two screws, one each side, from left and right lower rear side covers. See Diagram 10.11.2. Depress the tab at the rear of the covers and remove the left and right rear side covers.

Diagram 10.11.2 - Lower Rear Side Covers

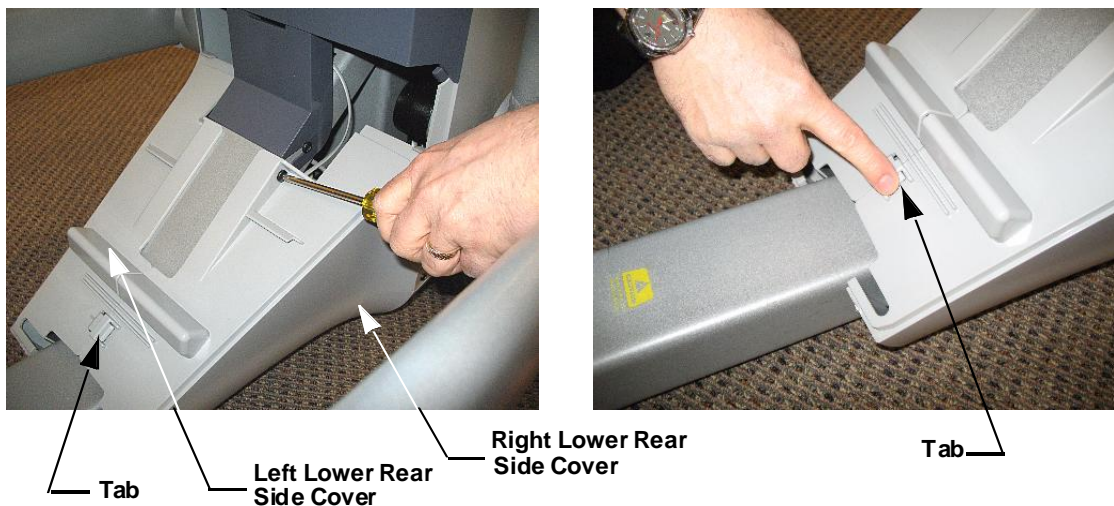

3. Support the upper rear cover and remove both screws from the bottom of the cover. See Diagram 10.11.3. Remove the upper rear cover.

Diagram 10.11.3 - Upper Rear Cover

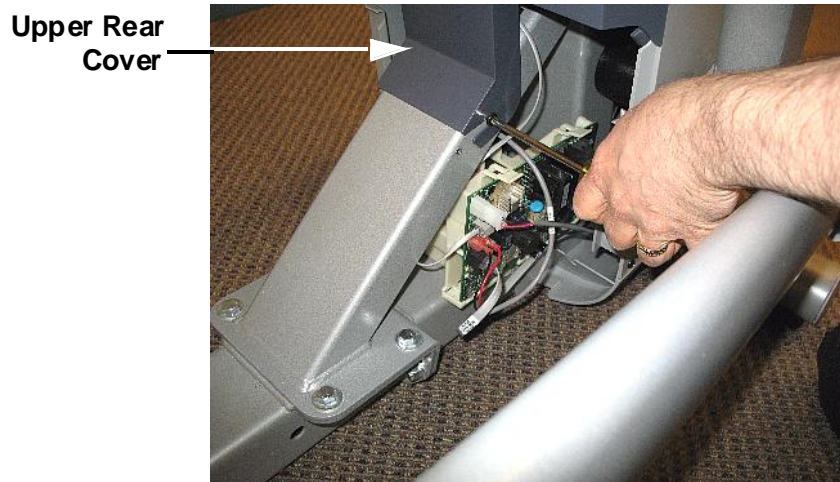

4. Remove two screws from the bottom edge of both side covers and remove both covers. See Diagram 10.11.4.

Diagram 10.11.4 - Side Covers

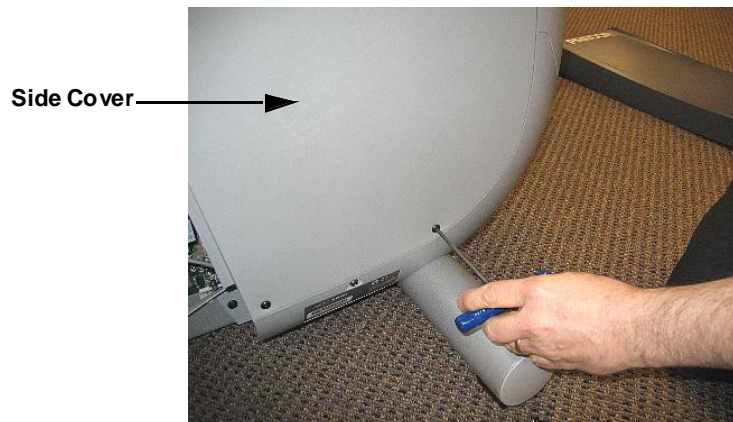

5. Remove two screws from the lower portion of the front cover. Grasp the lower portion of the front cover and remove the front cover. See Diagram 10.11.5.

Diagram 10.11.5 - Front Cover

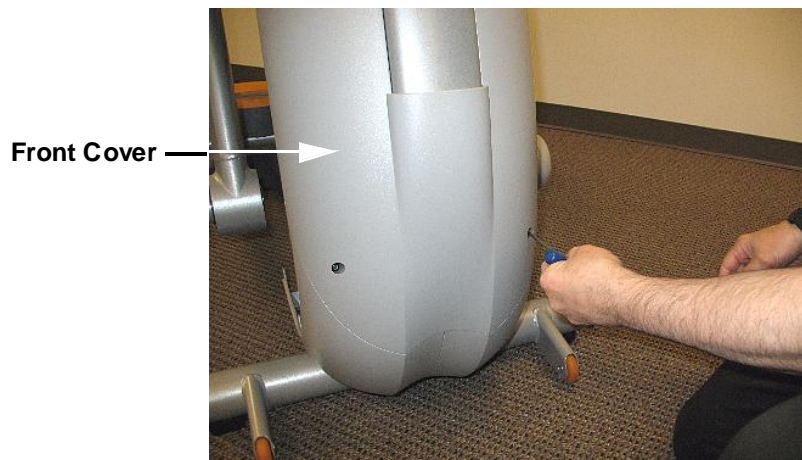

### Cover Installation

6. Slide the front cover into its mounting position and fasten it with the two screws removed in step 5.
7. Slide the right side cover into its mounting position with the lip on the cover behind the upper dark gray cover, behind the front cover and the tab at the bottom of the side cover into the clip in the lower cover. See Diagram 10.11.6. Fasten the cover with the screws removed in step 4.
8. Replace the left side cover using the procedure described in step 7.

Diagram 10.11.6 - Side Covers

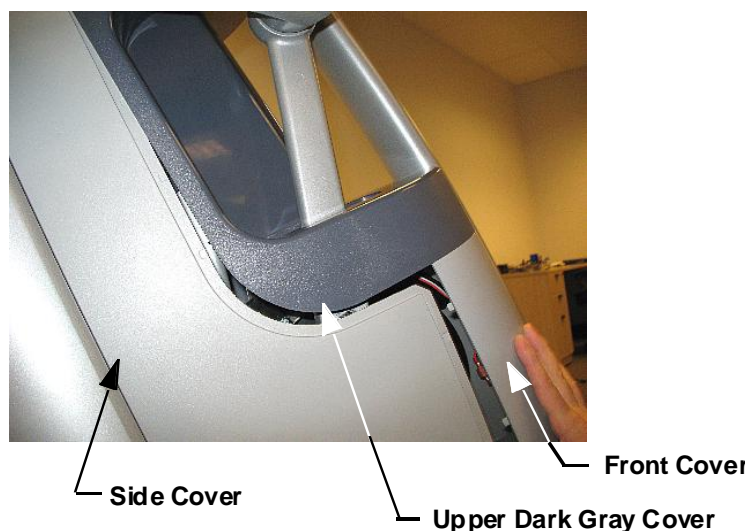

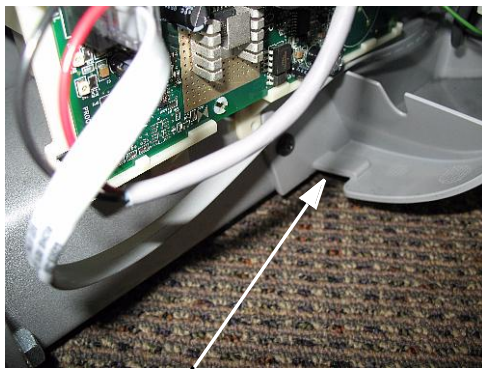

9. Set the right rear side cover in its mounting position and engage the tab at the front of the cover in the clip in the lower cover. Set the left rear side cover in its mounting position and engage the tab at the front of the cover in the clip in the lower cover. Engage the tab and clip at the rear of the left and right rear side covers. See Diagram 10.11.7. Fasten the left and right rear side covers with the screws removed in step 2.

**Diagram 10.11.7 - Lower Rear Side Covers****Clip in Lower Cover****Tab and Clip  
Lower Rear Covers**

Set the upper rear cover in its mounting position. First, slide the upper portion of the cover into place. See Diagram 10.11.8. Press downward on the rear portion of the cover and snap it into place.

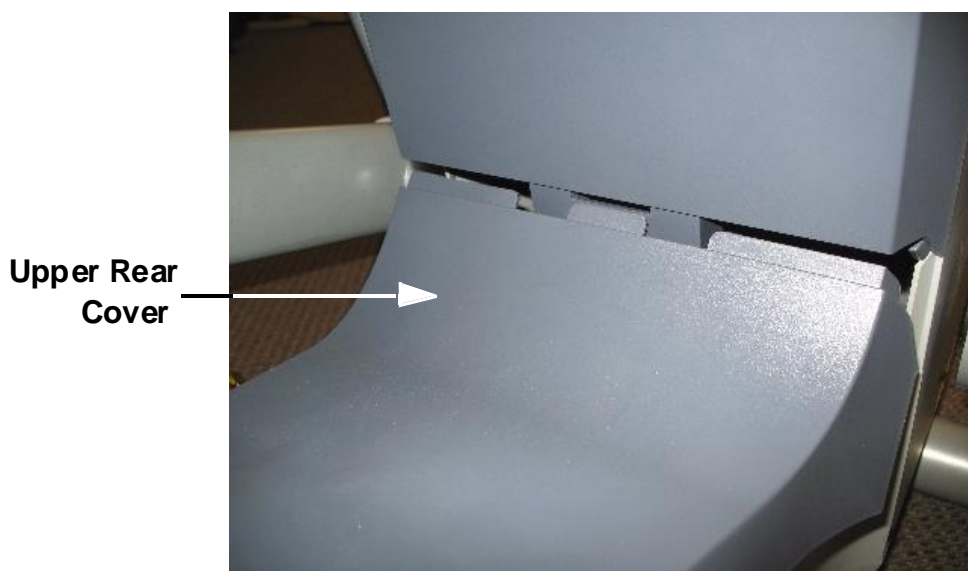
**Diagram 10.11.8 - Upper Rear Cover****Upper Rear  
Cover**

## Procedure 10.12 - Replacing a Rear Link

1. Remove the screws from the lower half of the upper cover. Remove the upper half of the upper cover. The lower half of the upper cover will be removed later. See Diagram 10.12.1.

Diagram 10.12.1 - Upper Arm

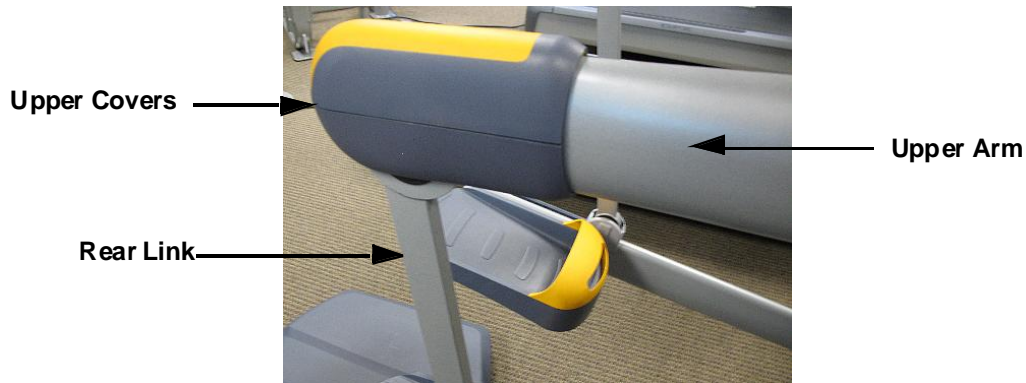

2. Use a flat bladed screwdriver to depress the tab in the lower cover and slide the lower cover up on the rear link. See Diagram 10.12.2.

Diagram 10.12.2 - Releasing the Lower Cover

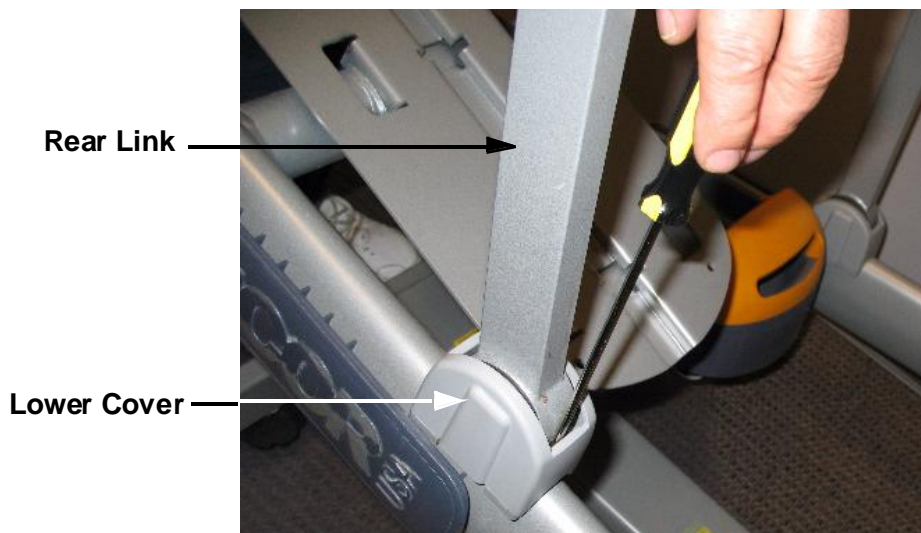

3. Place a 9/16 end wrench on each of the hex head bolts that fasten the upper arm to the rear link. These bolts thread into a free floating shaft, remove one of the two bolts.
4. Visually, inspect the shaft where the bolt was removed in step 3. If a 1/4 hex slot is visible, hold the shaft with a 1/4 allen wrench and remove the remaining bolt, skip step 5. If the 1/4 hex slot is not visible, continue with step 5.
5. Place a 9/16 end wrench on each of the hex head bolts that fasten the upper arm to the rear link. These bolts thread into a free floating shaft, remove one of the two.
6. Thread a 3/8 X 16 bolt that is approximately 2 inches long with jam nut, not provided, into the hole that the bolt was just removed from and tighten the jam nut. The bolt and jam nut will hold the shaft in place and allow removal of the remaining mounting bolt. Remove the remaining mounting bolt. Loosen the jam and remove the bolt with jam nut. See Diagram 10.12.3.

Diagram 10.12.3 - Using a Bolt and Jam Nut

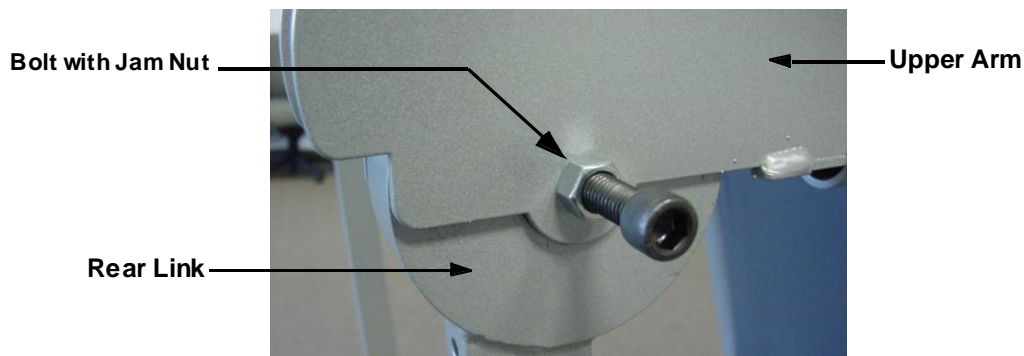

7. Separate the upper arm from the rear link. Slide the lower half of the upper cover and the lower cover off of the rear link.
8. Remove the lower end of the rear link from the stairarm using a similar procedure as in steps 3 to 6.
9. If you are reusing the rear link mounting hardware, apply blue loctite to the bolts and allow sufficient time for the loctite to cure. New replacement hardware does not need to have loctite applied because it utilizes a loctite patch.
10. Set the replacement rear link in its mounting position on the stairarm. Use a quarter inch allen wrench to hold the free floating shaft, thread one of the mounting bolts into the other side of the free floating shaft and torque it to 100 to 110 inch pounds. Thread another mounting bolt into the free floating shaft and torque it to 100 to 110 inch pounds.
11. Slide the lower cover onto the rear link and snap it into place. Slide the lower half of the plastic cover onto the rear link.
12. Fasten the rear link to the upper arm using the procedure in step 10.
13. Place the upper half of the upper cover in its mounting position, slide the lower half of the upper cover up to its mounting position and fasten it with the hardware removed in step 1.

## Procedure 10.13 - Upper Arm Replacement

1. Remove the two screws that fasten the plastic covers on the end of the upper arm. Remove the top cover and slide the bottom cover down the rear link to the stairarm.

Diagram 10.13.1 - Upper Arm Cover

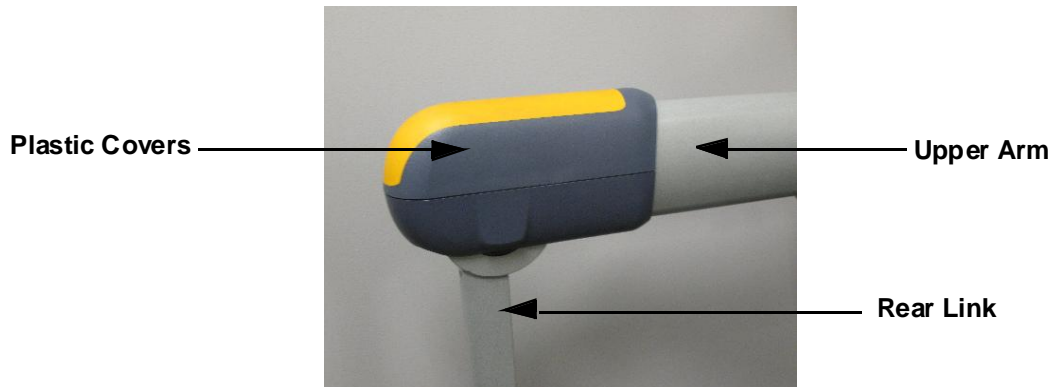

2. Place a 9/16 end wrench on each of the hex head bolts that fasten the upper arm to the rear link. These bolts thread into a free floating shaft, remove one of the two bolts.
3. Visually, inspect the shaft where the bolt was removed in step 2. There is a 1/4 hex slot in the shaft, hold the shaft with a 1/4 allen wrench and remove the remaining bolt.
4. Separate the upper arm from the rear link.

Diagram 10.13.2 - Upper Connecting Rod Removal

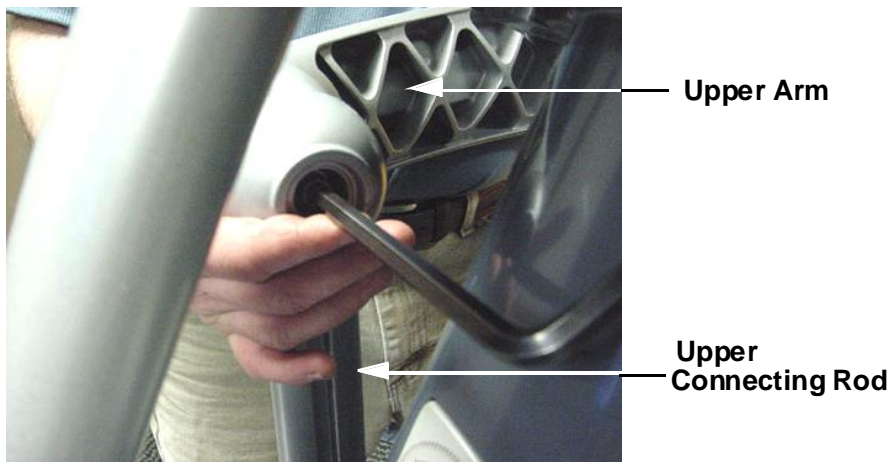

5. Remove the large end cap from the center of the upper.

6. Remove, and retain for later use, the large snap ring from the center of the upper arm and remove and save the large black plastic washer. Remove the upper arm from AMT and discard.
7. Slide both of the inner bearing races and black plastic spacer off of the upper arm mounting shaft and discard. See Diagram 10.13.3. Retain the black plastic spacer for later use.

Diagram 10.13.3 - Bearing Removal.

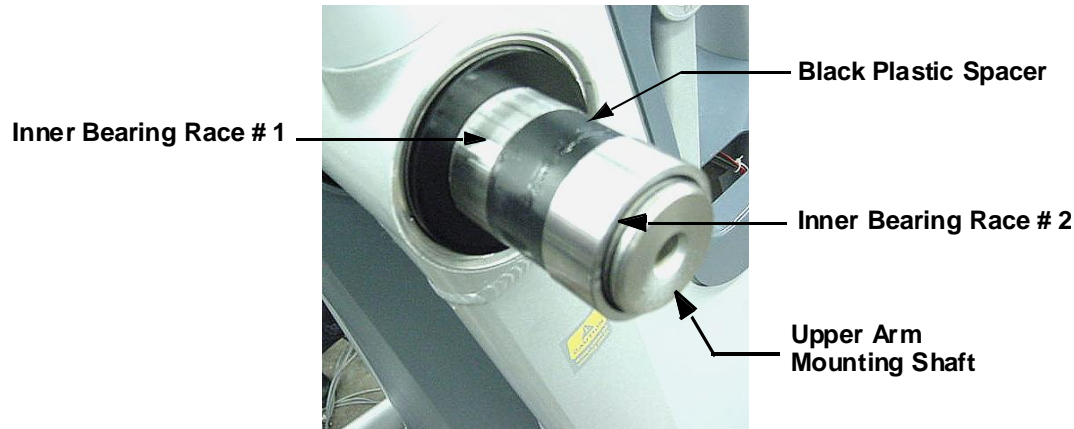

8. Slide inner bearing race #1 onto the upper arm mounting shaft.
9. Ensure that the white plastic washer is on the upper arm, see Diagram 10.13.4, slide the replacement upper arm onto inner bearing race #1 and into the upper connecting rod.
10. Slide the black plastic spacer and inner bearing race # 2 into the upper arm. If necessary, carefully tap it into place with a rubber mallet. See Diagram 10.13.4.

Diagram 10.13.4 - Bearing Replacement

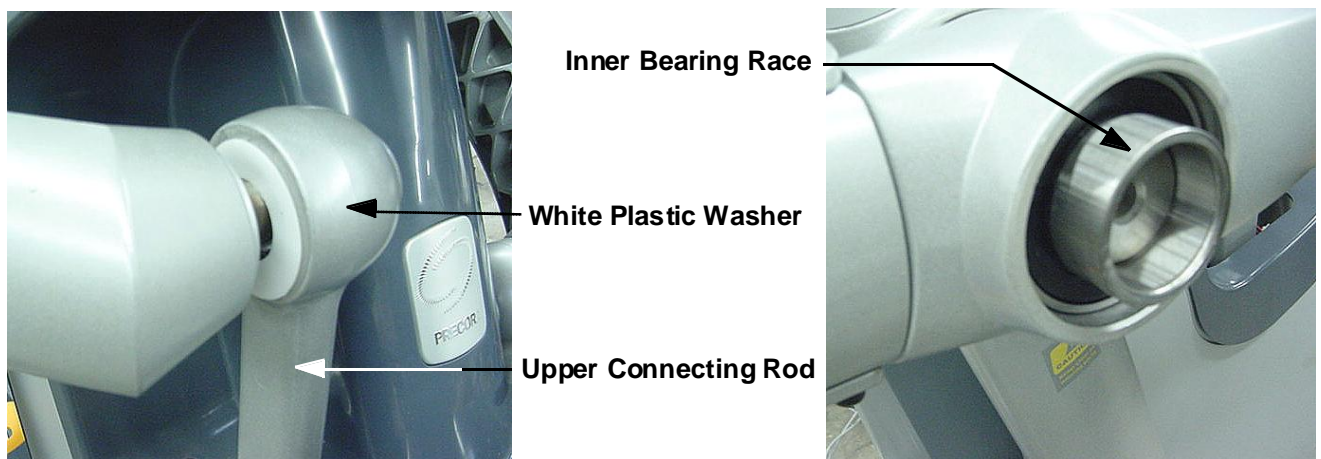

11. Slide the large black washer, removed in step 8, onto the upper arm mounting shaft and fasten the upper arm with the snap ring removed in step 8. replace the large end cap removed in step 6. It may be necessary to replace the large end cap if it no longer fits securely in the upper arm.
12. Fasten the upper arm to the upper connecting rod with the bolt removed in step 5. Torque the bolt to 17 - 21 foot pounds (200 - 250 inch pounds).
13. If you are reusing the rear link mounting hardware, apply loctite accelerator and blue loctite to the bolts. New replacement hardware does not need to have loctite applied because it utilizes a loctite patch.
14. Set the replacement rear link in its mounting position on the upper arm. Use a quarter inch allen wrench to hold the free floating shaft or the bolt and jam nut as described in step 4, thread one of the mounting bolts into the other side of the free floating shaft and torque it to 100 to 110 inch pounds. Thread another mounting bolt into the free floating shaft and torque it to 100 to 110 inch pounds.
15. Set the upper arm's top cover in place and slide the bottom cover up the rear link. Fasten the covers with the screws removed in step 1.
16. Repeat steps 1 through 16 with the remaining upper arm.
17. Thoroughly test all AMT functions.

## Procedure 10.14 - Front Arm Replacement

- Slide the cover up on the moveable handlebar, remove the two bolts that fasten the moveable handlebar to front arm. Remove the moveable handlebar from the front arm. See Diagram 10.14.1.

Diagram 10.14.1 - Moveable Handlebar

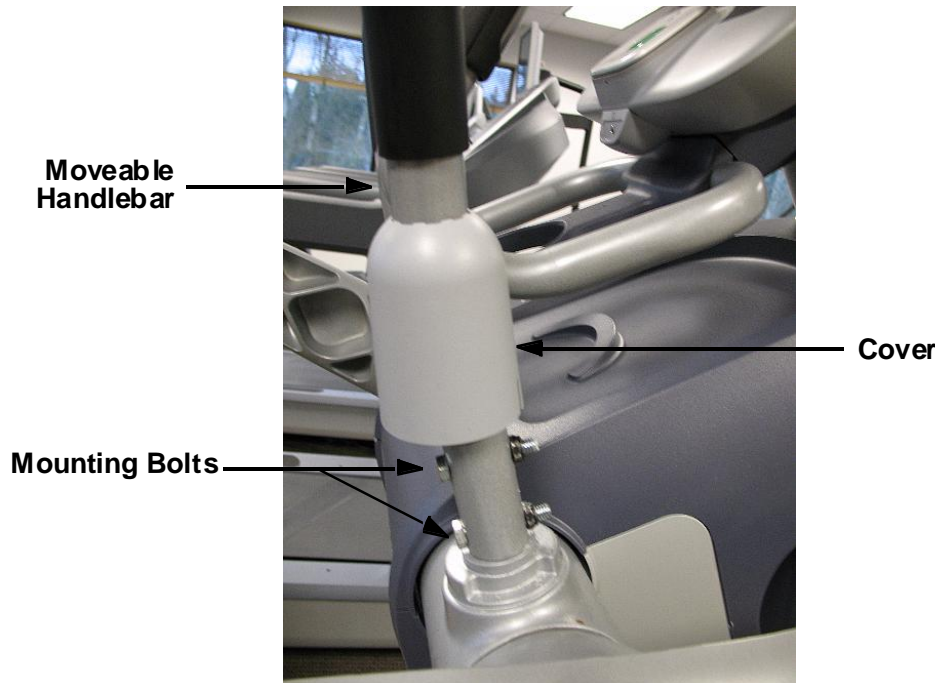

- Follow Procedure 10.8, steps 1-4. Remove the stairarm from the front arm.
- There are four bearings in the front arm assembly. The inner races of the bearings are not attached to the bearings and may come loose when the stairarm is removed. See Diagram 10.8.3.
- Remove the upper arm per Procedure 10.13, steps 1 to 9.
- Slide the inner bearing race and black plastic spacer off of the upper arm mounting shaft and retain for later use. See Diagram 10.13.3.
- Slide the front arm off of the upper arm mounting shaft.
- Clean the upper arm mounting shaft to remove any dried grease, dirt or debris.
- Slide the replacement front arm into place on the upper arm mounting shaft.
- Replace the upper arm per Procedure 10.13, steps 10-19.
- Remove the spacer, the inner race, two large washers and a wave washer from the stairarm. The clearance between the stairarm shaft and the inner race is very small. It is very easy to jam the inner race on the stairarm shaft.
- Carefully, clean the stairarm shaft to remove any dried grease, dirt or debris.

Section Eleven - Future Content

Section Twelve - Future Content

Section Thirteen - Future Content



## Section Fourteen - Wiring Diagrams

## Wiring Diagram 14.1 - AMT

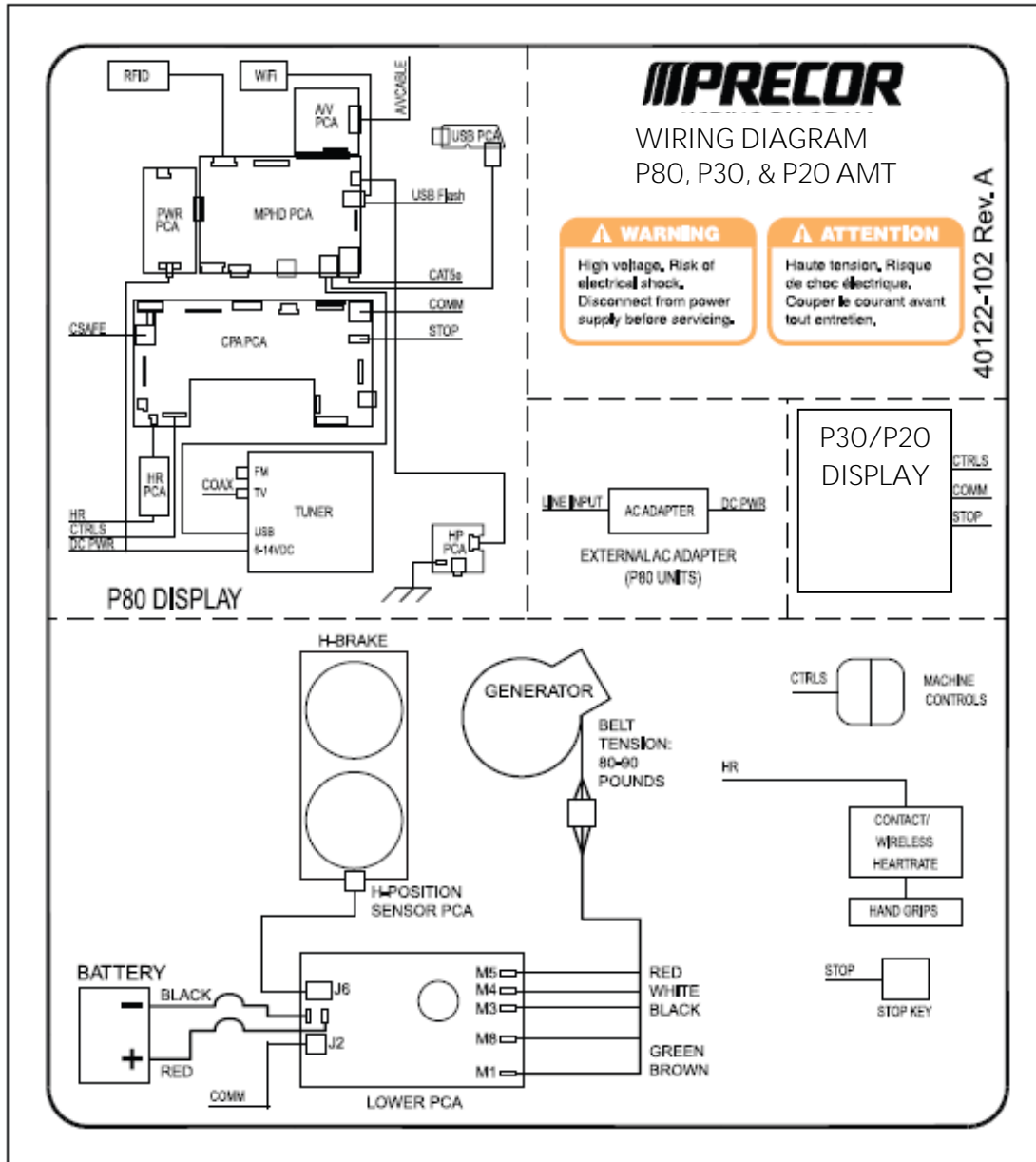

## Block Diagram 14.2 - AMT 835

